

## StreetWise™

# Ceramic Metal Halide Lamp™

### NEW Generation Tubular Lamps



DATA SHEET

## Product information

Until now, public authorities and other organisations have had to choose between high cost, high quality outdoor illumination or low cost alternatives which, even at peak efficiency, make streets and other areas look dingy or dull.

Tungsramp's new generation of CMH StreetWise™ lamps especially designed for outdoor lighting offers the best of both worlds. Bright, white, 'natural' light and low costs for both running and maintenance.

With CMH lighting, streets and other public spaces can feel safer for pedestrians. More than that, their "daylight" colour rendering improves the ability of drivers to recognise shapes and colours, especially in peripheral vision. This also promotes quicker driver response times.

## Product range

Tungsramp's new, feature-rich product range expands offerings both in new installations and replacements from 50-150W. Standard, robust base of E27 and E40 provides easy installation. The whole range delivers cost savings combined with excellent lamp quality characteristics and a long re-lamp cycle.

## Application areas



Road and Tunnel



Street and Pedestrian



Commercial areas / city beautification / architectural



Car Park

## Features

- Very efficient, up to 110lm/W
- Outstanding lumen maintenance, at least 80% at 12,000 hours
- Dimmable to achieve further energy saving
- Direct retrofit to HPS
- Best white light alternative for mercury, HPS and standard ceramic solutions
- Long life 24,000 hours
- System flexibility - operates on both electronic and electromagnetic ballasts
- Lowest cost new system - standard base, standard ballast, standard optics
- Universal burning position

# Specification summary

Wattage (W)	Colour	Normal Length [mm]	Product Description	CCT [K]	CRI [Ra]	Cap	Rated Average Life [h]	Pack Qty	Product Code
50	WDL	156	CMH50/TT/UVC/U/730/E27 STREETWISE TU	3,000	70	E27	24,000	12	93102245
70	WDL	156	CMH70/TT/UVC/U/730/E27 STREETWISE TU	3,000	70	E27	24,000	12	93102211
100	WDL	211	CMH100/TT/UVC/U/730/E40 STREETWISE TU	3,000	70	E40	24,000	12	93102210
150	WDL	211	CMH150/TT/UVC/U/730/E40 STREETWISE TU	3,000	70	E40	24,000	12	93102212

General	Units	50W	70W	100W	150W
Product Code		93102245	93102211	93102210	93102212
Rated Initial Lumens on Electronic Gear - Horizontal	[lm]	5,250	7,640	10,900	16,200
Rated Initial Lumens on Electronic Gear - Vertical	[lm]	5,200	7,100	10,300	15,250
Rated Wattage (ECG)	[W]	51.5	73	100	147
Rated Wattage (EM)	[W]	54.5	72	98	150
Weighted Energy Consumption	[kWh/1000hrs]	59.9	79.2	107.80	165.00
Rated Initial Lumens on Magnetic Gear - Horizontal	[lm]	5,450	7,300	10,500	16,300
Rated Initial Lumens on Magnetic Gear - Vertical	[lm]	5,250	7,300	9,800	15,350
Rated Efficacy on Electronic Gear - Horizontal	[LpW]	102	104.6	109	110.2
Rated Efficacy on Electronic Gear - Vertical	[LpW]	101	99	103	103.8
Rated Efficacy on Magnetic Gear - Horizontal	[LpW]	100	101.4	107	109
Rated Efficacy on Magnetic Gear - Vertical	[LpW]	99	101.4	99	102,3
Energy Efficiency Class	[EEC]	A+	A+	A+	A+
Colour Temperature EM/ECG	[K]	3,000/3,000	3,000/3,000	3,000/2,900	3,000/2,900
Colour Rendering Index at 70% Power	[Ra]	60+	65+	65+	65+
Ambient Temperature	[°C]	25	25	25	25

## Starting Characteristics<sup>1</sup>

Time To Start	[s]	< 30	< 30	< 30	< 30
Hot Restart Time (Maximum)	[min.]	15	15	15	15

<sup>1</sup> Typical values (actual values will be ballast dependent)

## Through Life Performance - Horizontal operation

Lumen Maintenance At 12000 Hrs (% Of Initial Lumens)	%	85	85	80	80
Rated Life Horizontal B5	[h]	13,500	13,500	13,500	9,500
Rated Life Horizontal B10	[h]	16,000	16,000	16,000	12,000
Rated Life Horizontal B20	[h]	18,800	18,800	18,800	15,800
Average Rated Life Horizontal B50	[h]	24,000	24,000	24,000	24,000

## Through Life Performance - Vertical Operation

Lumen Maintenance At 12 000 Hrs (% of Initial Lumens)	%	85	85	80	80
Rated Life Vertical B5	[h]	13,500	13,500	6,000	6,000
Rated Life Vertical B10	[h]	16,000	16,000	8,500	8,500
Rated Life Vertical B20	[h]	18,800	18,800	12,000	12,000
Average Rated Life Vertical B50	[h]	24,000	24,000	20,000	20,000

## Safety Requirements

Maximum Allowed Bulb Temperature Under Abnormal Conditions <sup>2</sup>	[°C]	320	320	400	400
Maximum Base Temperature	[°C]	210	210	250	250

<sup>2</sup> For a bare lamp running at 1.25 x normal operating power to simulate the most unfavourable conditions of high line voltage and low ballast impedance in a fixture environment.  
\*Rated life at launch, life tests are ongoing.

Luminaire Characteristics	Enclosed	Enclosed	Enclosed	Enclosed
---------------------------	----------	----------	----------	----------

Note that the lamp voltage inside the luminaire should not deviate by more than 5V from the bare lamp voltage in free air. Thermal protection recommended

## Electrical Characteristics

Operating Position		Universal	Universal	Universal	Universal
Lamp Power (Rated)	[W]	54.5	72	98	150
Lamp Voltage - Horizontal	[V]	87	92	100	100
Lamp Voltage - Vertical	[V]	82	87	94	94
Lamp Current	[A]	0.74	0.95	1.16	1.8
Max. Ignition Voltage	[kV]	5	5	5	5
Conventional Ballast Required	[W]	HPS ballast and HPS ignitor	HPS ballast and HPS ignitor	HPS ballast and HPS ignitor	HPS ballast and HPS ignitor
Ballast Impedance at 230V	[V/A]	257	197	155	106
Power Factor Correction Capacitor	[uF]	8	10	12	20
Mercury Content	[mg]	15.8	15.3	13.1	13.6

## Dimensions

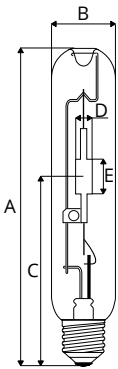

		50 W Tubular	70 W Tubular	100 W Tubular	150 W Tubular
Product Code		93102245	93102211	93102210	93102212
A - lamp MOL	[mm]	154+/-2 (max. 156)	154±2 (max. 156)	209±2 (max. 211)	209±2 (max. 211)
B - bulb diameter max.	[mm]	39	39	48	48
C - lamp LCL nominal	[mm]	102	102	132	132
D - arc tube diameter	[mm]	8.6	6.7	8.1	9.6
E - burner height	[mm]	14.4	17.5	17.7	23.3
Arc tube eccentricity	[°]	3	3	3	3
Base type		E27	E27	E40	E40

## Lamp life

Life survival graph is shown for statistically representative batches of lamps operated under controlled nominal conditions with an 11 hours per start switching cycle. The declared lamp life is the median life, which is when 50% of the lamps from a large sample batch would have failed. Lamp life in service will be affected by a number of parameters, such as supply voltage variation, switching cycle, operating position, mechanical vibration, luminaire design and control gear. The information is intended to be a practical guide for comparison with other lamp types. The determination of lamp replacement schedules will depend upon the acceptable reduction in illuminance and the relative costs of spot and group replacement.

Note: Lamps were measured on magnetic ballast.

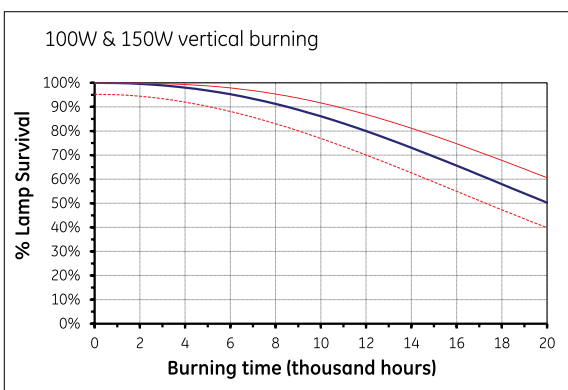
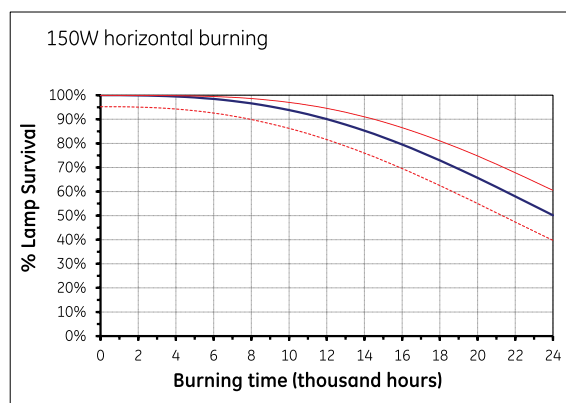
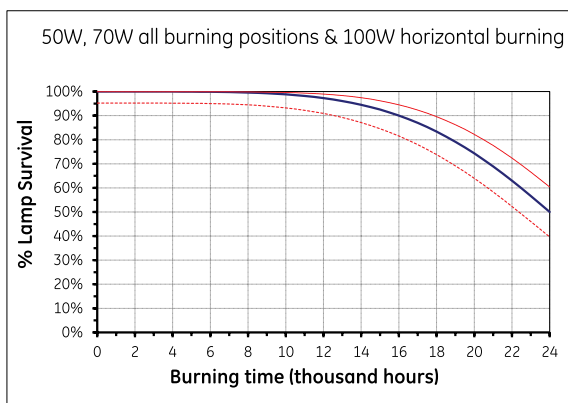

## Lumen maintenance

The lumen maintenance graph shows how the luminous output decreases throughout life. All metal halide lamps experience a reduction in light output and a very slight increase in power consumption through life. Consequently there is an economic life when the efficacy of the lamp falls to a level at which is better to replace the lamp and restore the illumination. Where a number of lamps are used within the same area it may be well worth considering a group lamp replacement programme to ensure uniform output from all the lamps. Curves are representing 11 hours per start cycle, less frequent starting will improve lumen maintenance.

Note: Representative curves are for horizontal orientation and measured on magnetic ballast.

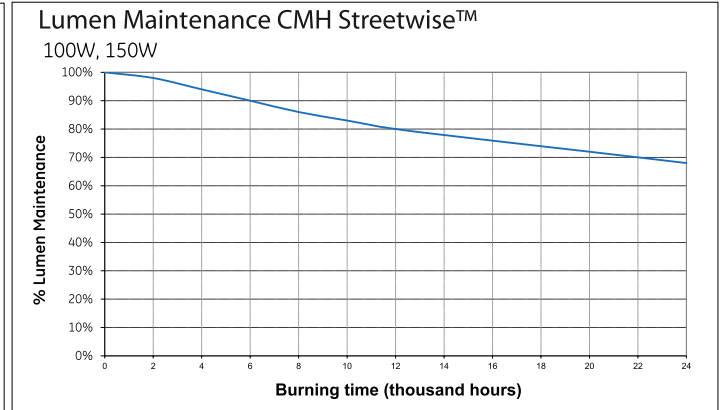
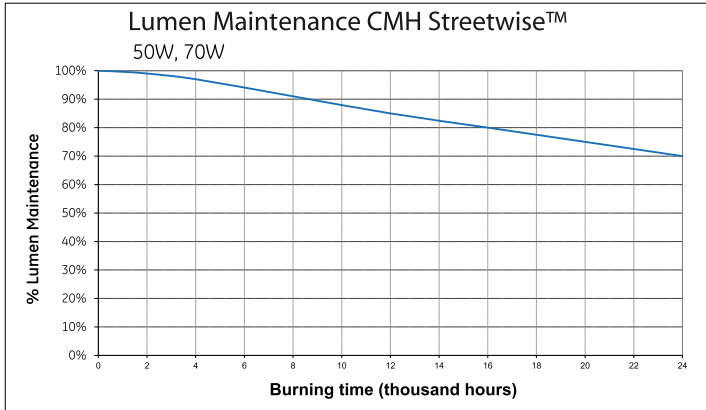

## Spectral power distribution

Representative spectral power distribution curve is provided in the following diagram.

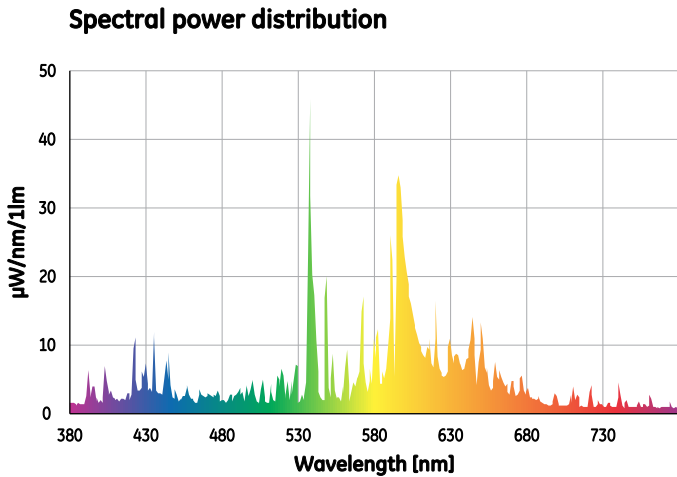

## Distribution of luminous intensity

The following diagram show polar light intensity curves for lamp base-up orientation:

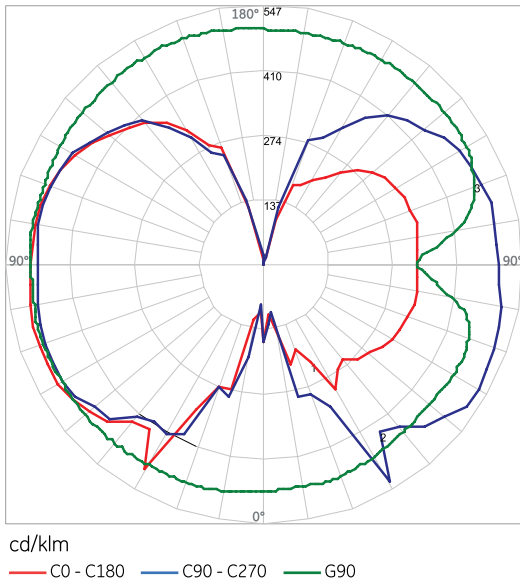

## Warm-up characteristics

During the warm-up period immediately after starting, lamp temperature increases rapidly and mercury as well as the metal halides evaporate within the arc tube. The lamp current and voltage will stabilise in less than 4 minutes. During this period the light output will increase from zero and the colour will approach the correct visual effect as each metallic element becomes vaporised.

### Typical warm-up characteristics 50w, 70W, 100W, 150W StreetWise™ lamps

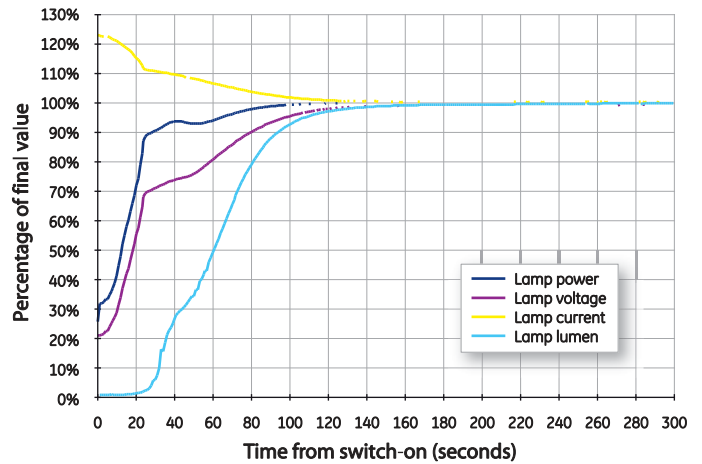

## Supply voltage sensitivity

The line supply voltage applied to the control gear should be as close to rated nominal as possible. Lamps will start and operate at 10% below rated supply voltage but this should not be considered as a normal operating condition. In order to maximise lamp survival, lumen maintenance and colour uniformity, supply voltage and rated ballast voltage should be within  $\pm 3\%$ . Supply variations of  $\pm 5\%$  are permissible for short periods only. Where supply voltage variation is likely to occur the use of electronic control gear should be considered as this type of equipment is normally designed to function correctly for a voltage range of 200-240V

## Dimming

There is an increasing demand to maximise energy savings of light sources. While HID lamps are inherently very efficient, many users would like to further increase the energy savings of HID lamps through dimming.

Dimming systems that maintain the open circuit voltage to the lamp (such as magnetic systems with variable impedance, or electronic square wave ballasts with dimming function) can be approved for standard life warranty with dimming down to 65% power. The lumen maintenance and colour appearance may be substantially affected when dimming down to 50% of rated power.

Each lamp in the CMH StreetWise™ range can be dimmed up to 65% of its rated power.

This means that the operating power of the lamp can be reduced below its nominal rating. This greatly increases installation flexibility and opportunities to reduce energy costs through the operational cycle of the application.

The reliability and lumen maintenance of the CMH Streetwise™ lamps are not affected by dimming operation.

The colour performance of lamps in the StreetWise™ range is such that CCT and Ra are similar when dimmed at similar relative % powers. This means that lamps may be mixed in implementation and operated on the same dimming circuit with appealing overall appearance.

- Dimming ballasts start at full power, remain there for 15 minutes, and then the lamps may be dimmed.
- Dimming is supported on electronic ballasts or magnetic systems that can maintain the open circuit voltage.
- When a StreetWise™ lamp is dimmed, approximately: 90% power = 90% rated lumens; 80% power = 75% rated lumens; 70% power = 65% rated lumens; 60% power = 50% rated lumens
- The colour rendering of CMH Streetwise™ lamps is 70 at full power and about 65 at 65% power.
- The CCT of CMH StreetWise™ lamps increases by about 400K when dimmed to 65% power.

Dimming systems that reduce line voltage: down to 85% of line voltage is acceptable with StreetWise lamps on a typical reactor ballast. In this case the light output will be reduced by about 35%, with about 25% system energy savings. Line voltage dimming may shorten the life of the lamps.

For such systems, it is important to reduce the line voltage slowly to avoid premature lamp cycling, especially with older lamps that are already high in voltage and close to the normal drop out point.

In changing from the full-power mode to the reduced-power mode, the time between full power and reduced power must be no less than ninety seconds, and the rate of change of power at any power level between full power and reduced power must be no greater than that corresponding to a linear (uniform) reduction between those extremes in a ninety-second time interval.

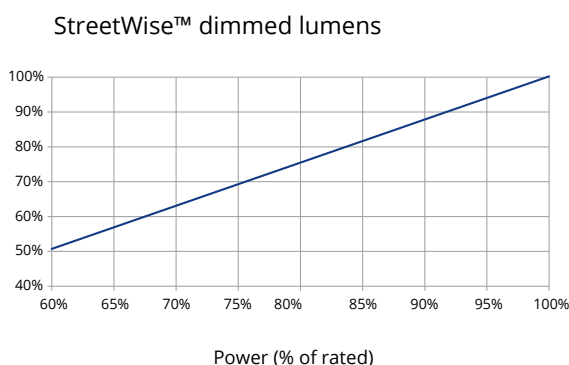
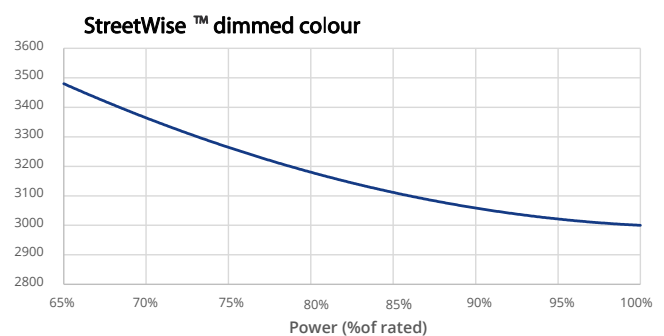
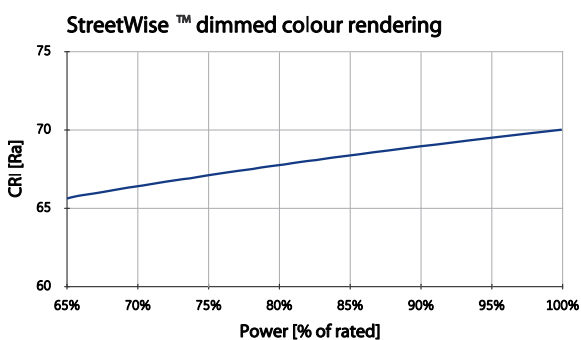

## End of life conditions

The principal end of life failure mechanism for CMH lamps is arc tube leakage into the outer jacket. At the high operating temperatures inside the arc tube, the corrosive dose material can eventually cause leakage after a long period of time. Arc tube leakage into the outer jacket can be noticed by a sudden significant lumen drop and a perceptible color change (the color usually turns green).

IEC 60662 and IEC 62035 warn of a risk that at the end of lamp life a number of lamps may exhibit a rectifying effect. Thermally protected ballasts or ballasts resistant to rectification are recommended by GE Lighting.

See Fusing Recommendations.

## UV and damage to sensitive materials

The wall of the bulb, which is produced with specially developed 'UV Control' material, absorbs potentially harmful high energy UV radiation emitted by the ceramic arc tube.

The use of UV control material together with an optically neutral front glass cover allows the lamp to significantly reduce the risk of discolouration or fading of products. Luminaires should not be used if the front glass is broken or missing. It is recommended that a safety interlock switch is incorporated into the luminaire to prevent operation when the luminaire is opened.

Finally the selection of luminaire materials should take into consideration the UV emission. Current UV reduction types on the market are optimised for UV safety of human eye and skin exposure. However, luminaire materials may have different wavelength dependent response functions. Designers must take account of emission in each of the UV-A, UV-B and UV-C spectral ranges as well as material temperatures when designing luminaires.

## Information on luminaire design

### Ballasts

CMH operate from the same ballast impedance as conventional High Pressure Sodium systems. The use of thermal protection or ballast protection is good practice for these lamps. This safety device will protect the circuit at end of lamp life should partial rectification occur due to electrode imbalance or arc tube failure.

### Stray magnetic field of conventional ballast

At the design stage for fixtures incorporating the control gear, careful consideration should be given to the physical layout of the lamp and ballast. The relative positions and distance between lamp and ballast can adversely affect lamp performance and drastically reduce lamp life survival.

Conventional magnetic ballasts can produce a stray magnetic field and if the lamp is placed within this field, "bowing" of the arc in the discharge tube can occur. Since ceramic is a very rigid material severe arc bowing can cause high thermal stress leading to cracking or rupture of the arc tube resulting in failure of the lamp early in life.

In fixtures where the ballast is necessarily placed close to the lamp, use of magnetic shielding is essential. Another solution is to use an electronic ballast, which eliminates the need for an ignitor, simplifies wiring, reduces the risk of stray magnetic field and eliminates light output flicker.

### Containment requirement

CMH lamps operate above atmospheric pressure, therefore a very small risk exists that the lamp may shatter when the end of life is reached. Though this failure mode is unlikely, containment of shattered particles is required as defined by IEC 62035.

Single-ended lamps should only be used in a suitable enclosed luminaire with front cover glass capable of containing the fragments of a lamp should it shatter

# Control gear and accessories

## Electronic ballasts

StreetWise™ lamps can be operated both on electronic and electromagnetic ballasts.

Advantages of electronic ballasts are:

- Good regulation against supply voltage variation
- Reduced weight of control gear
- Reduced electrical power losses
- Ballast noise reduced/eliminated
- Single piece compact unit
- Reduced wiring complexity in the luminaire

System Performance on electronic ballast (estimated)		50W	70W	100W	150W
System Power	W	56,6	79	108	158
System Efficacy	lm/W	93	97	101	102.5
Lumens	lm	5,250	7,640	10,900	16,200
Lamp Power	W	51.5	73	100	147
Lamp Efficacy	lm/W	102	105	100	100.2
Lamp Voltage Range	V	72-92	77-97	84-104	84-104

## Electronic ballast circuitry

The ballasts should comply with the relevant parts of the following standards:

- RFI suppression EN 55015
- Harmonics EN 61000-3-2
- Immunity EN 61547
- Safety EN 60926/EN 60928/EN 61347
- Performance EN 60927/EN 60929

**Note:** Tungstram can test electronic gear for compatibility. For specific requests please contact your local representative or visit [www.tungstram.com](http://www.tungstram.com).

## Suitable ignitors

Operating on both HPS and Metal halide lamp ignitors with minimum requirements: 1 pulse/half cycle, 30 second ignition time and compliant to the related ignition specification in HPS IEC60662 performance standard (for HPS types).

## Superimposed ignitors

In many installations Ceramic Metal Halide lamps are operated from a conventional magnetic ballast in conjunction with a superimposed ignitor. These ignitors generate starting pulses independently from the ballast and should be placed close to the lamp, preferably within the luminaire. Wiring between ignitor and lamp should have a maximum capacitance to earth of 100pF (length equivalent to less than 1 Metre) – contact ignitor manufacturer for details of specific ignitor types. A typical circuit diagram is shown.

## Impulser ignitors

Impulser type ignitors use the ballast winding as a pulse transformer and can only be used with a matched ballast. Always check with the ballast and ignitor supplier that components are compatible. Longer cable lengths between ballast & ignitor and the lamp are possible due to the lower pulse frequency generated, giving greater flexibility for remote control gear applications. Ignitor pulse characteristics at the lamp must however comply with specified minimum values for CMH lamps under all conditions.

### Typical superimposed ignitor circuit

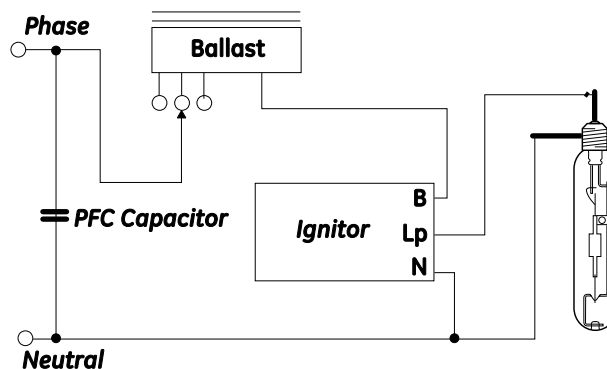

### Typical impulser ignitor circuit

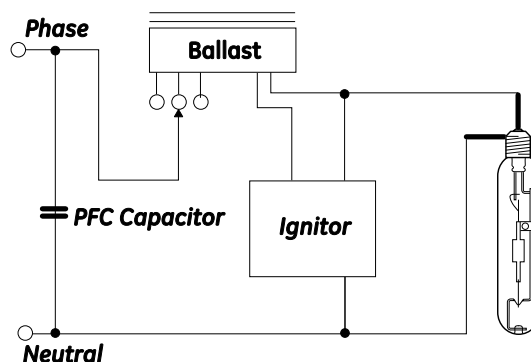



## Other ignitor related considerations

### Timed or cut-out ignitors

The use of a “timed” or “cut-out” ignitor is not a specific requirement for CMH lamps but it is a good optional safety feature worth considering to protect the ignitor from overheating and to prolong its life. If used, the timed period must be adequate to allow lamps to cool and restart as described in the previous section. A period of 10-15 minutes continuous or intermittent operation is recommended before the ignitor automatically switches off. Timed ignitors specifically offered for High-Pressure Sodium lamps where the period of operation is only about 5 minutes are not suitable for CMH lamps.

### Warm re-starting

The combined characteristics of ceramic arc tube material and vacuum outer jacket result in CMH lamps cooling relatively slowly. It is possible with low energy ignitors to reach the required breakdown voltage but not create a full thermionic discharge. Under these conditions the lamp can remain very warm and be prevented from cooling to a temperature at which the arc can be re-established. To avoid this, turn off the power supply for approximately fifteen minutes or change to a suitable high energy ignitor from the list given in the superimposed ignitor section.

## Fusing recommendations

For a very short period immediately after switch-on, all discharge lamps can act as a partial rectifier and the ballast may allow higher than the normal current to flow. In order to prevent nuisance fuse failure the fuse ratings must take account of this. See relevant information on national installation requirements for High Intensity Discharge lighting circuits. Single fusing is recommended which gives added protection for the end-of-life condition when partial rectification can also occur. HBC or MCB (type 3 or 4) fuse ratings for single and multiple lamp installations.

Number of Lamps	1	2	3	4	5	6
50W Fuse Rating [A]	4	4	6	6	10	10
70W Fuse Rating [A]	4	4	6	6	10	10
100W Fuse Rating [A]	4	4	6	10	10	10
150W Fuse Rating [A]	4	6	10	10	16	16

## Safety warnings

The use of these products requires awareness of the following safety issues:

### Warning

#### Risk of electric shock

- Turn power off before inspection, installation or removal
- Do not use where directly exposed to water or outdoors without an enclosed fixture

#### Risk of fire

- Keep combustible materials away from lamp
- Use in luminaire rated for this product which complies with UL1598 or IEC 60598
- Use thermally protected ballast in accordance with IEC 61167 and IEC62035

#### Unexpected lamp rupture may cause injury, fire, or property damage

- Use in ENCLOSED luminaire with front cover made of glass capable of containing the fragments of a lamp should it shatter, to avoid risk of fire.
- DO NOT operate lamp in a luminaire with a missing or broken lens diffuser
- Do not exceed rated voltage
- Do not use lamp if outer glass is scratched or broken
- Use only properly rated ballast and ignitor
- Operate lamp only in specified position
- Do not use beyond rated life
- Do not turn on lamp until fully installed

**A damaged lamp emits UV radiation which may cause eye/skin injury**

## Cautions

### Risk of burn

- Allow lamp to cool before handling

### Lamp may shatter and cause injury if broken

- Wear safety glasses and gloves when handling lamp
- Do not use excessive force when installing lamp
- Do not stare at light source. May be harmful to the eyes. Not applicable to diffuse coated bulbs.
- Dispose of lamp in a closed container
- For operating instructions see electronic catalog / data sheet at [www.gelighting.com](http://www.gelighting.com)
- Tungsram Lighting accepts no liability for injury or damage resulting from incorrect use of the lamp, or from use of the lamp in combination with inappropriate equipment.
- Consult your supplier if you have any questions or concerns.

**Always follow the supplied lamp operation and handling instructions.**

## Operating instructions

- Check that the replacement lamp is the correct type for the application (I.e. Wattage rating, base type and control gear).
- We recommend that the lamp be used in luminaires with a safety interlock lens switch.
- For total supply load refer to ballast manufacturers electrical data.
- To maximize lamp survival and lumen maintenance the supply voltage and ballast design voltage should be within  $\pm 3\%$ .
- The lamp requires a period of time to re-strike after a power interruption or a severe voltage dip.
- In order to prevent damage to the ballast and the ignitor, the lamp should be replaced as quickly as possible at the end of its lifetime (marked change in colour, flickering, failure to start.)
- When illuminating light-sensitive materials or at high light levels, additional UV filtration is recommended.
- The phase should be connected via the ballast to the central contact of the lamp. If in a star distribution system, and power factor correction is being applied, this should be done by means of capacitors between line and neutral. In case of audio frequency switching signals on the mains, a filter coil must be applied.
- Strong magnetic fields may impair lamp performance and in the worst case lead to lamp rupture. Reduce stray magnetic fields for "Streetwise" lamps by shielding or use on electronic ballast. Separation of magnetic ballast from the arc tube has to be at least 100 mm. In case of any shorter distance desired, please contact your local Tungsram representative.
- FOR USE ON DIMMING SYSTEMS

Contact your local Tungsram Lighting sales representative