

Ceramic Metal Halide Lamp PAR 20 & PAR 30 35W and 70W



DATA SHEET

Product information

CMH lamps combine the HPS technology (providing stability, efficiency & uniformity) and the Metal Halide Technology (bright white quality light) to produce highly efficient light sources with good colour rendering and consistent colour performance through life. This is achieved by using the ceramic arc tube material from the Lucalox lamp, which minimises the chemical changes inside the lamp through life. When combined with the halide doses used in Metal Halide lamps then the quality and stability of the dose maintains the colour consistency. Hence the name CMH. Metal halide lamps, traditionally made with quartz arc tubes, are prone to colour shift through life and lamp-to-lamp colour variation. Some of the dose, e.g. sodium, (an important component of metal halide lamps), can migrate through quartz to cause colour shift and loss of light through life. The ceramic arc tube resists this material loss, can be manufactured to tighter tolerances and withstands a higher temperature to provide a more constant colour.

Application areas



Office



Retail



Commercial areas/city beautification/architectural



Hospitality

Features

- Excellent colour consistency
- High efficient compact source
- Unique 3-part ceramic arc-tube design provides higher durability resulting in better reliability
- Up to 13,000 hours Life
- High 80+ to 90+ colour rendering index (CRI)
- UV control
- 35W PAR 20&30 lamps operate on standard or electronic ballast (thermal protection needed)
- 70W PAR30 lamps operate on standard or electronic ballast (no thermal protection needed)

Specification summary

CMH PAR20

Product code	93104651	93104652
Product description	CMH35/PAR20UVC/U/830/E27/SP TU	CMH35/PAR20/UVC/U/830/E27/FL TU
Nominal wattage	35	35
Rated power [w]	38.8	38.8
Weighted energy consumption [kWh/1000 hrs]	42.68	42.68
Volts [V]	90	90
Cap	E27	E27
Candela [cd]	22,000	7,500
Rated peak intensity	21,945	7,500
Nominal useful lumens (90° Cone) [L]	2,215	2,215
Rated useful lumens (90° Cone) [L]	2,215	2,215
Energy efficiency class (EEC)	A	A
Beam Angle [°]	10	25
Rated beam angle [°]	11	24
Colour	830	830
Nominal CCT [K]	3,000	3,000
CRI	84	84
Operating position	U	U
Average rated life [h]	10,000	10,000
Switching cycles	909	909
Warmup time to 90% lumens [Sec]	90	90
Warmup time to 60% lumens [Sec]	60	60
Time to Start @ 10C [Sec]	<5	<5
Time to Start @ -15C [Sec]	<15	<15
Mercury content [Mg]	4.6	4.6
Pack quantity	15	15

CMH PAR30

Product code	93104653	93104654	93104649	93104668	93104691
Product description	CMH35/PAR30UVC/U/830/E27/SP TU	CMH35/PAR30/UVC/U/830/E27/FL TU	CMH70/PAR30/UVC/U/830/E27/WFL TU	CMH35/PAR30/UVC/U/942/E27/FL TU	CMH70/PAR30/UVC/U/942/E27/WFL TU
Weighted energy consumption [kWh/1000 hrs]	43.46	43.35	81,72	43.54	82.62
Volts [V]	90	90	90	90	90
Cap	E27	E27	E27	E27	E27
Nominal wattage	35	35	70	35	70
Rated power [w]	39.5	39.4	74,3	39.6	75.1
Candela [cd]	39,600	11,000	10,000	10200	9,000
Rated peak intensity	39,600	11,600	10,000	10753	91,05
Nominal useful lumens (90° Cone) [L]	2,449	23,68	44,02	2,194	39,80
Rated useful lumens (90° Cone) [L]	2,449	23,68	44,02	2,194	39,80
Energy efficiency class (EEC)	A	A	A	A	A
Beam Angle [°]	10	25	40	25	40
Rated beam angle [°]	10	25	37	25	38
Colour	830	830	830	942	942
Nominal CCT [K]	3,000	3,000	3,000	4,200	4,200
CRI	81	81	80	89	89
Operating position	U	U	U	U	U
Average rated life [h]	10,000	10,000	13,000	10,000	10,000
Switching cycles	909	909	1,182	909	909
Warmup time to 90% lumens [Sec]	90	90	110	90	110
Warmup time to 60% lumens [Sec]	60	60	75	60	75
Time to Start @ 10C [Sec]	<5	<5	<5	<5	<5
Time to Start @ -15C [Sec]	<15	<15	<15	<15	<15
Mercury content [Mg]	5.1	5.1	8	4.5	6.1
Pack quantity	6	6	6	6	6

Dimensions

CMH PAR 20

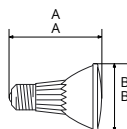

Nominal Length [mm]	A Maximum Length [mm]	B Maximum Diameter [mm]	Bulb Glass	Operating Position	Fixture Rating
82	92	64	Heat Resistant	Universal	Open

CMH PAR 30

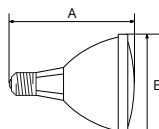

Nominal Length [mm]	A Maximum Length [mm]	B Maximum Diameter [mm]	Bulb Glass	Operating Position	Fixture Rating
119	124	95.5	Heat Resistant	Universal	Open

Spectral power distribution

CMH 35W 4200K spectral distribution

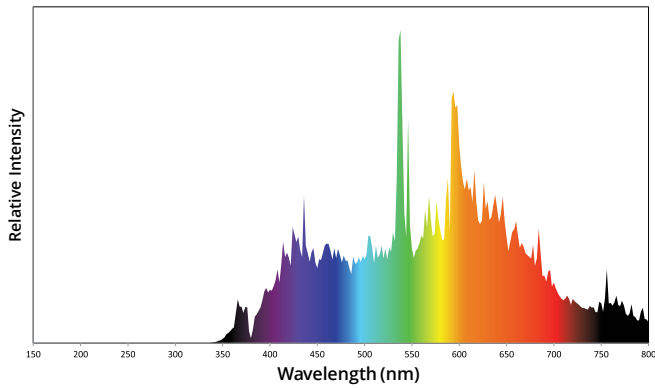

CMH 35W 3000K spectral distribution

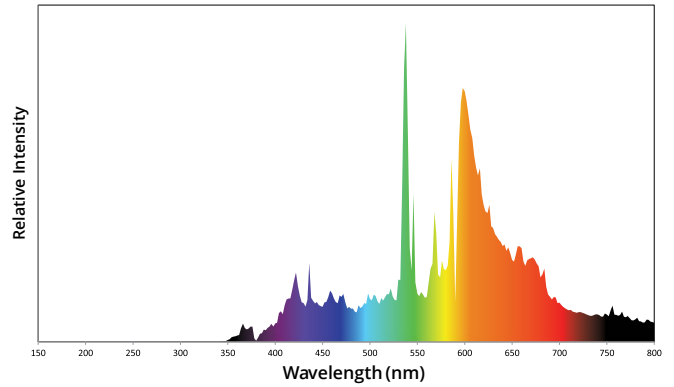

CMH 70W 4200K spectral distribution

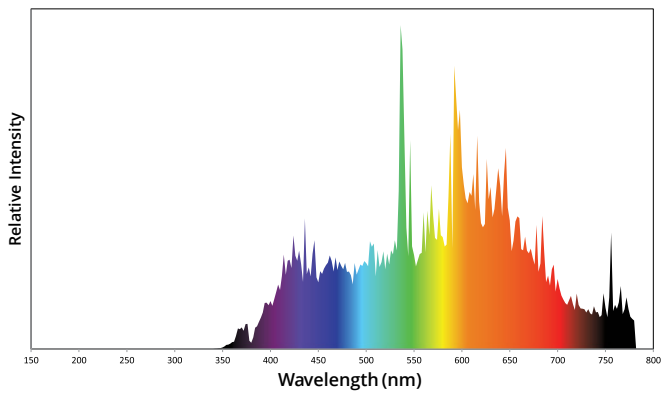

CMH 70W 3000K spectral distribution

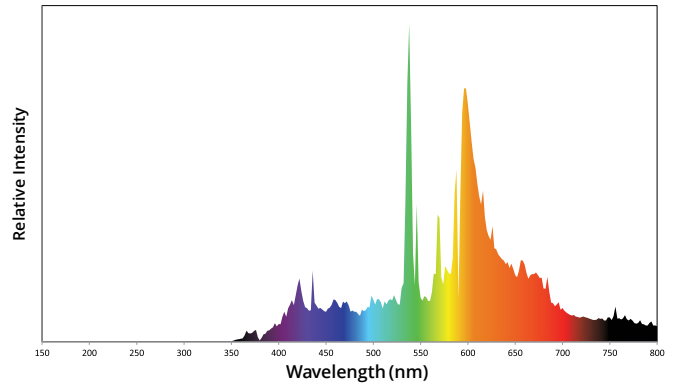

Lamp Current	Nominal Lumens	CBCP	CCT	Chromaticity coordinates		CRI
				X	Y	
3000K 35W						
0.53	2100	22000	3000	0.435	0.401	80+
0.53	2100	7500	3000	0.435	0.401	80+
0.53	2400	39600	3000	0.431	0.406	80+
0.53	2400	11000	3000	0.431	0.406	80+
4200K 35W						
0.53	2225	10200	4200	0.370	0.363	89
3000K 70W						
0.98	4700	10000	3000	0.436	0.41	80+
4200K 70W						
0.96	4300	9000	4200	0.370	0.373	89

Distribution of luminous intensity

35W PAR20 3000K SP

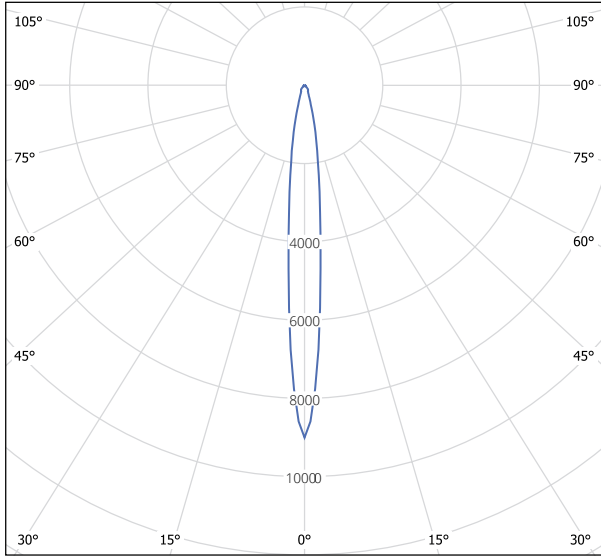

cd/klm

35W PAR20 3000K FL

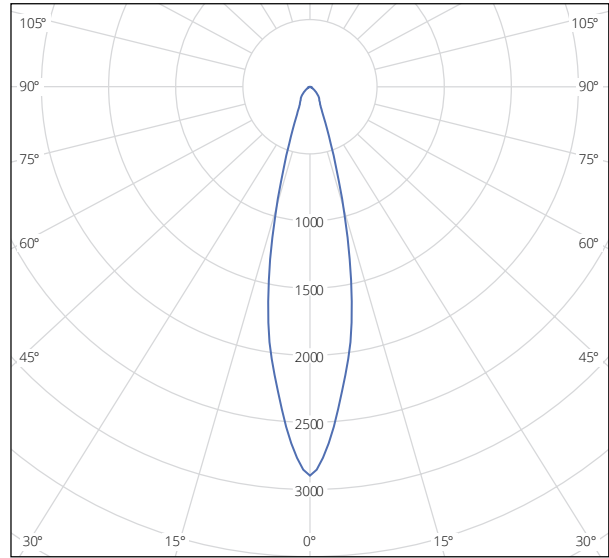

cd/klm

35W PAR30 3000K SP

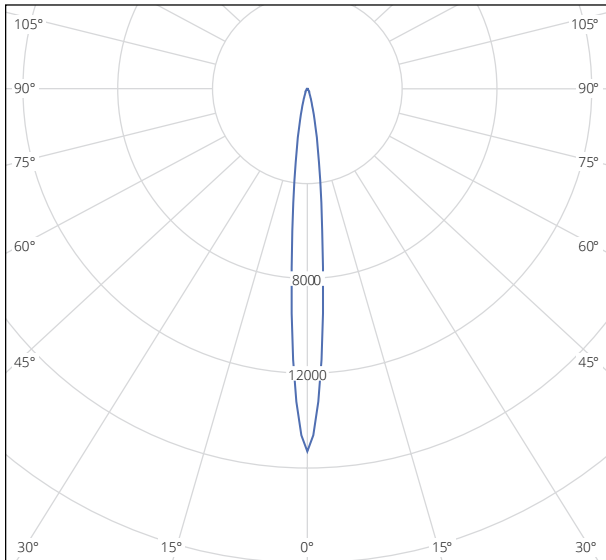

cd/klm

35W PAR30 3000K FL

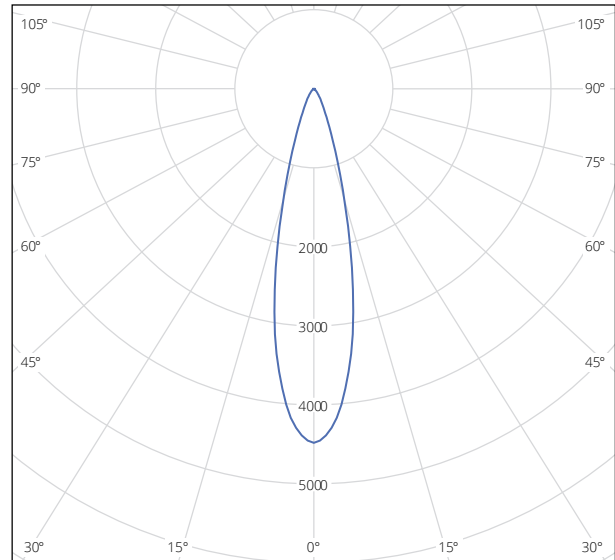

cd/klm

35W PAR30 4200K FL

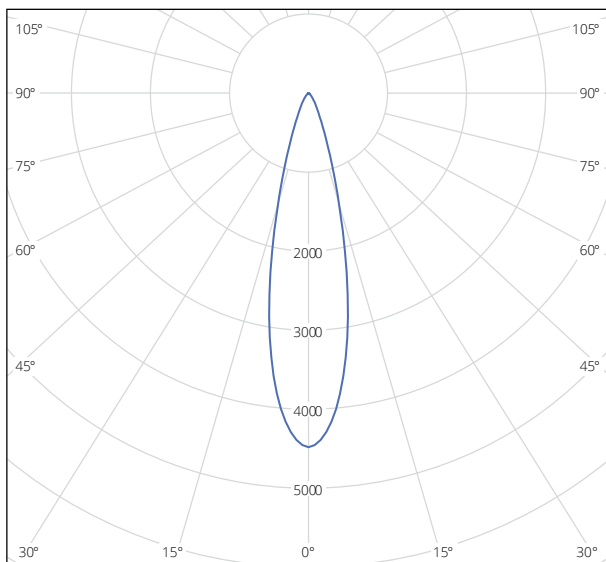

cd/klm

70W PAR30 3000K WFL

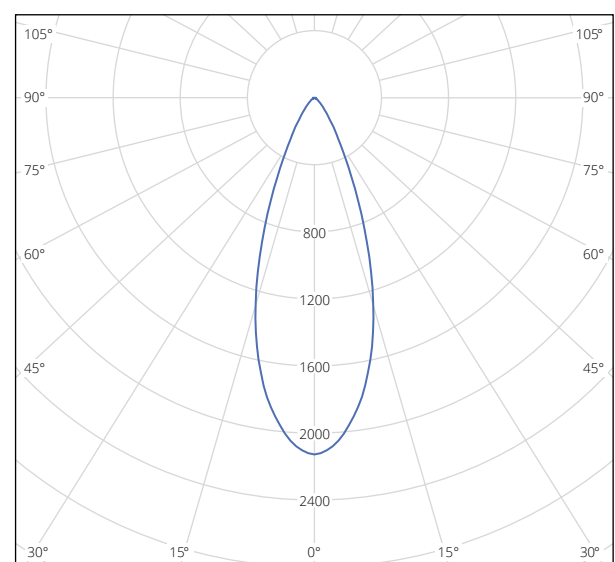

cd/klm

70W PAR30 4200K WFL

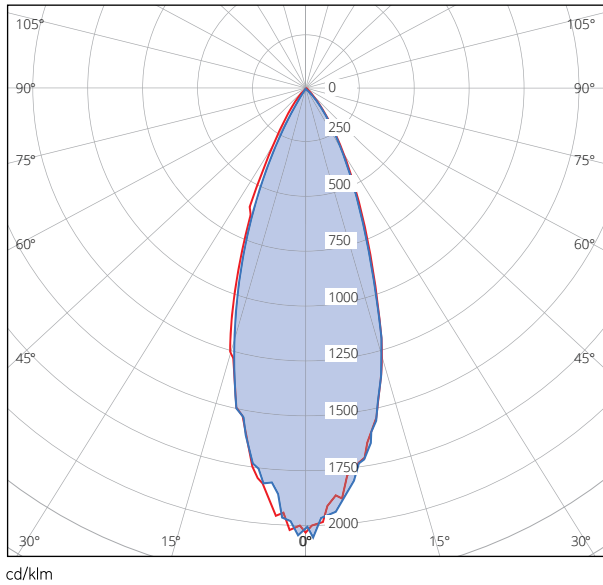

Distribution of luminous intensity

35W PAR20 3000K SP

Lamp to Surface Angle: 0°
Nominal Beam Angle: 10°

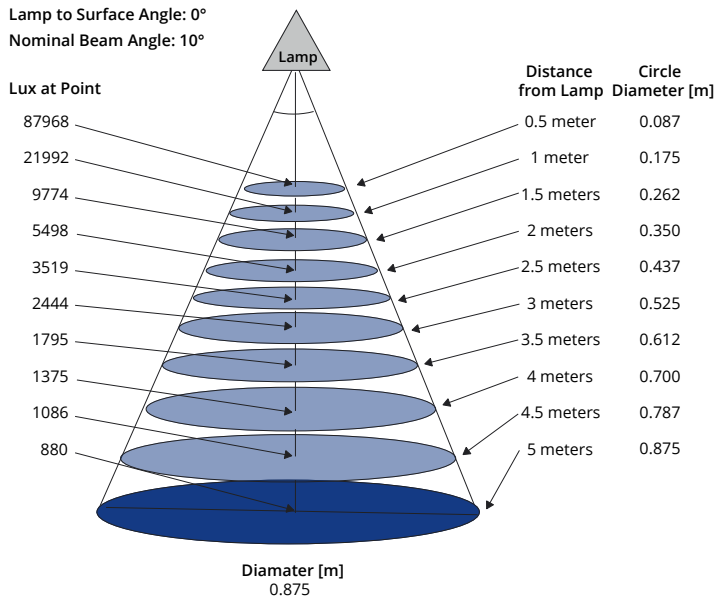

35W PAR20 3000K FL

Lamp to Surface Angle: 0°
Nominal Beam Angle: 25°

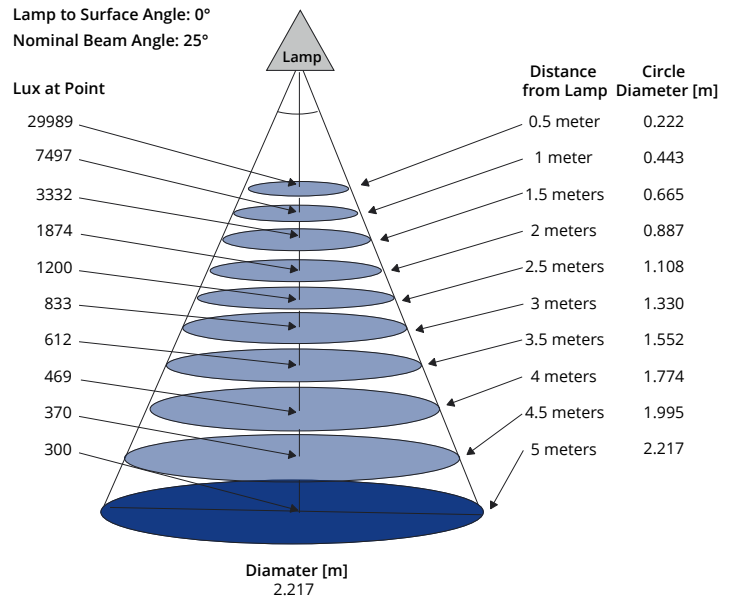

35W PAR30 3000K SP

Lamp to Surface Angle: 0°
Nominal Beam Angle: 10°

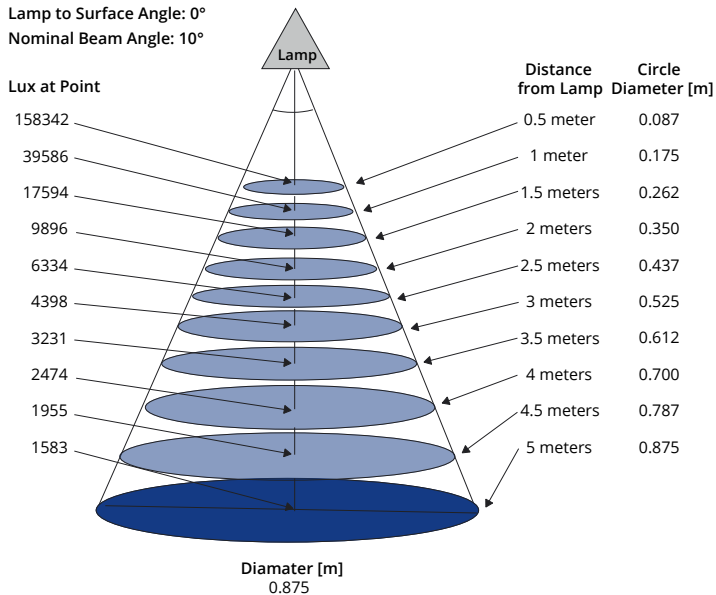

35W PAR30 3000K FL

Lamp to Surface Angle: 0°
Nominal Beam Angle: 25°

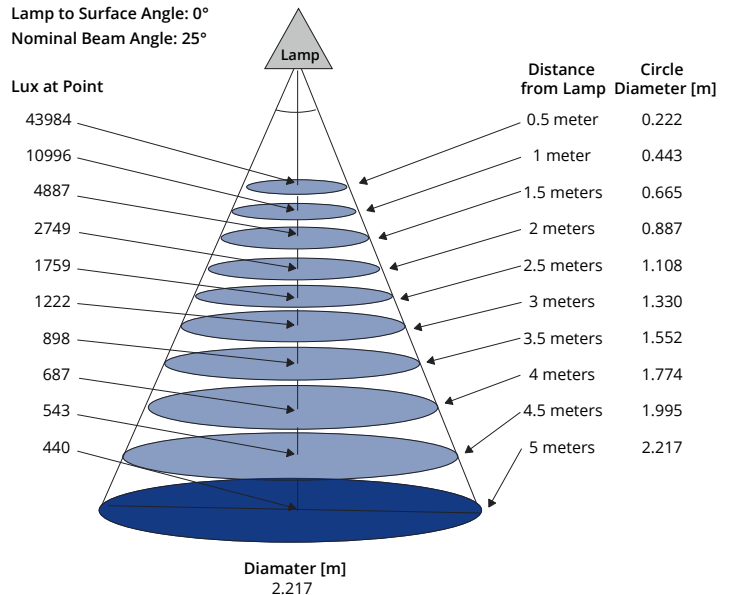

35W PAR30 4200 FL

Lamp to Surface Angle: 0°
Nominal Beam Angle: 25°

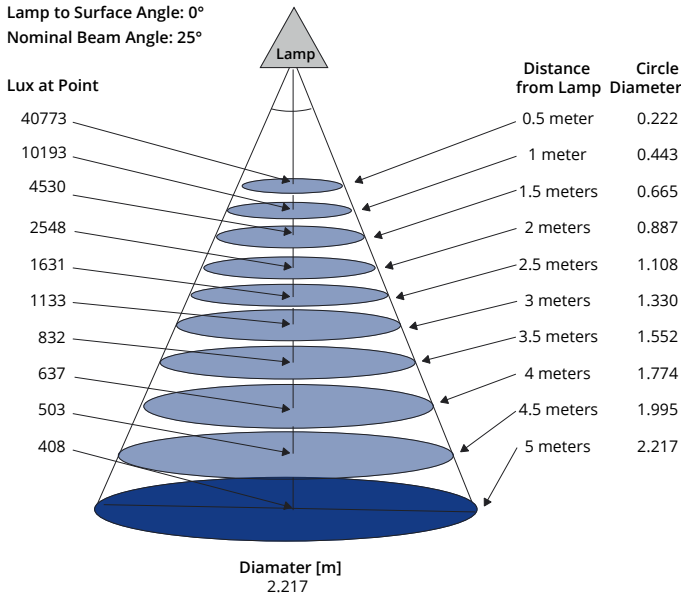

70W PAR30 3000K WFL

Lamp to Surface Angle: 0°
Nominal Beam Angle: 25°

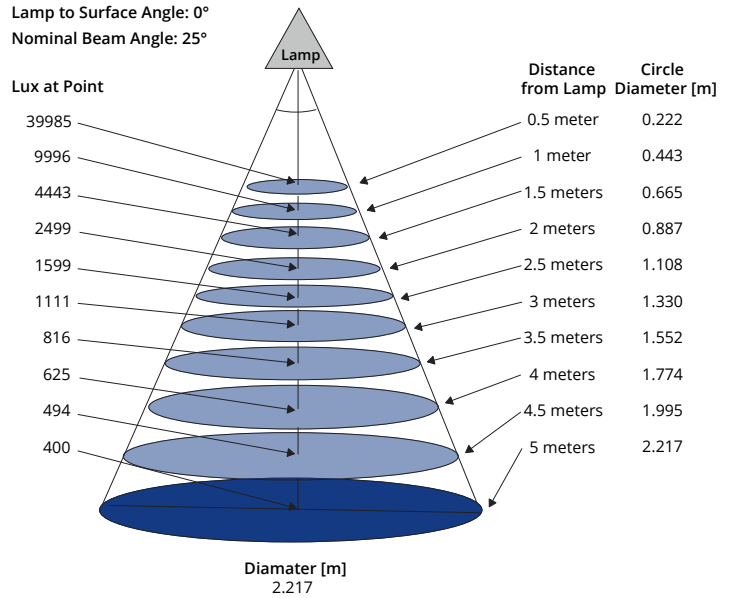

70W PAR30 4200 WFL

Lamp to Surface Angle: 0°
Nominal Beam Angle: 28.7°

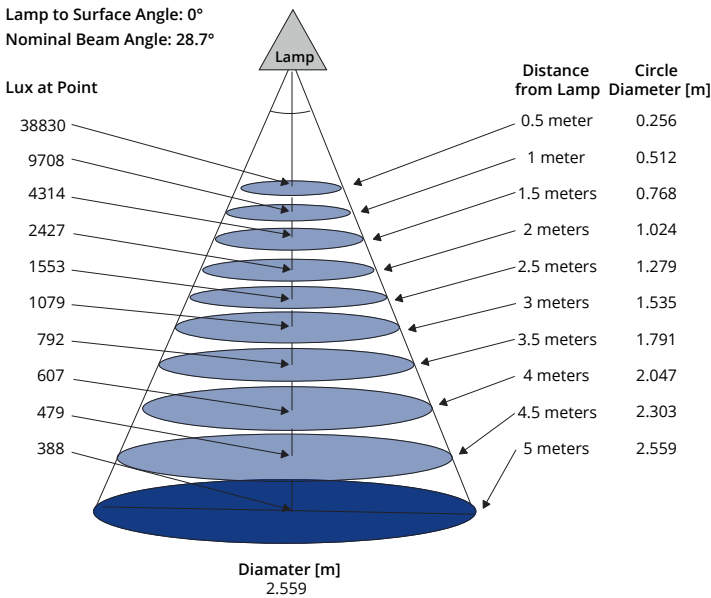

Lamp life

The graphs show the mortality curve of statistically representative batches of lamps operated under controlled conditions of 11 hours per start. The declared lamp life is the median life, which is when 50% of the lamps from a large sample batch would have failed. Lamp life in service will be affected by a number of parameters, such as supply voltage variation, switching cycle, operating position, mechanical vibration, luminaire design and control gear. The information is intended to be a practical guide for comparison with other lamp types. The determination of lamp replacement schedules will depend upon the acceptable reduction in illuminance and the relative costs of spot and group replacement.

Note: The representative curves are taken in Vertical Base Up position. Life performance can greatly increase in Horizontal Burning position

Lamp Survival CMH 35W 3000K PAR20 and PAR30

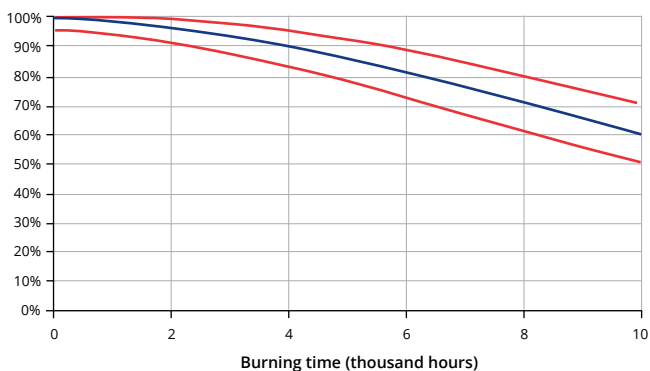

Lamp Survival CMH 70W 3000K PAR30

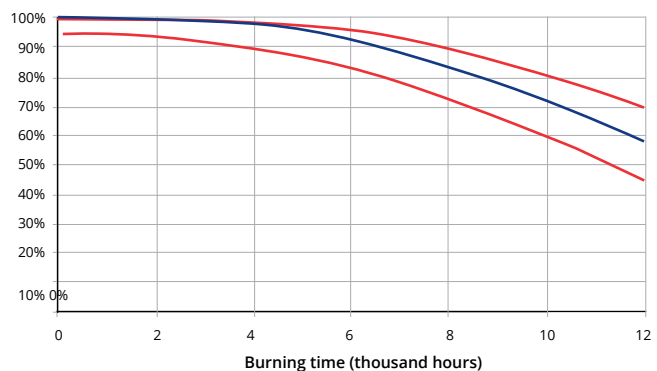

Lamp Survival CMH 35W 4200K PAR30*

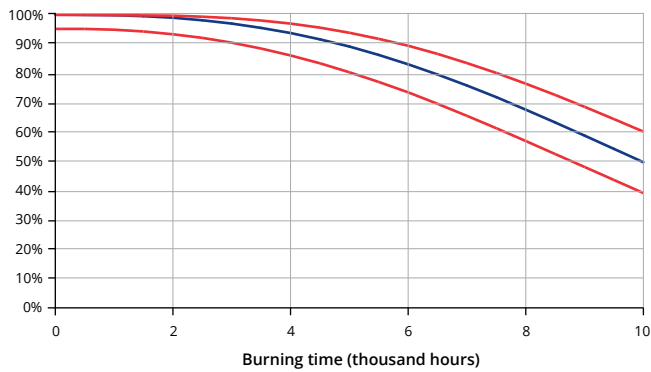

* Life rating on conventional ballast . Testing continues to validate 12000 Hours life.

Lumen maintenance

Lumen maintenance graph shows how the luminous output decreases throughout life. All metal halide lamps experience a reduction in light output and a very slight increase in power consumption through life. Consequently there is an economic life when the efficacy of the lamp falls to a level at which is better to replace the lamp and restore the illumination. Where a number of lamps are used within the same area it may be well worth considering a group lamp replacement programme to ensure uniform output from all the lamps. Curves are representing 11 hours per start cycle, less frequent starting will improve lumen maintenance.

Note: The representative curves are taken in Vertical Base Up position.

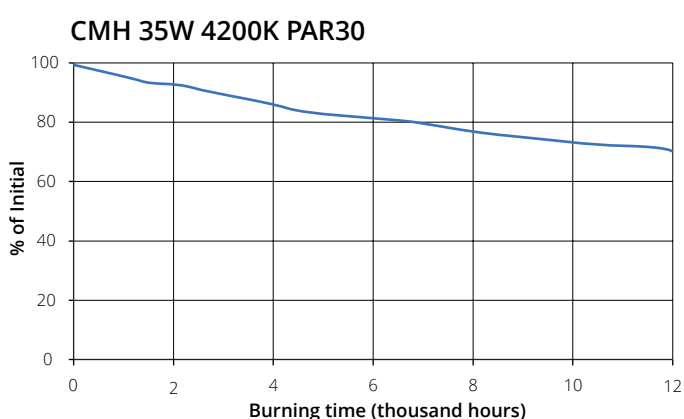
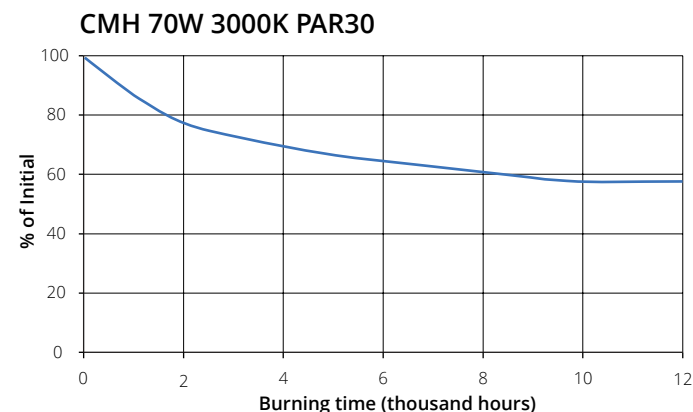
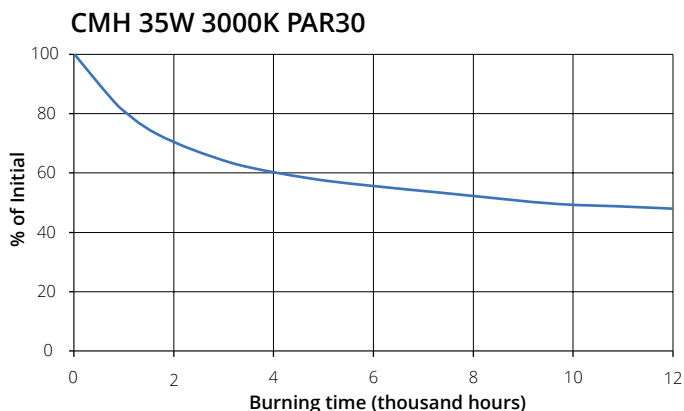
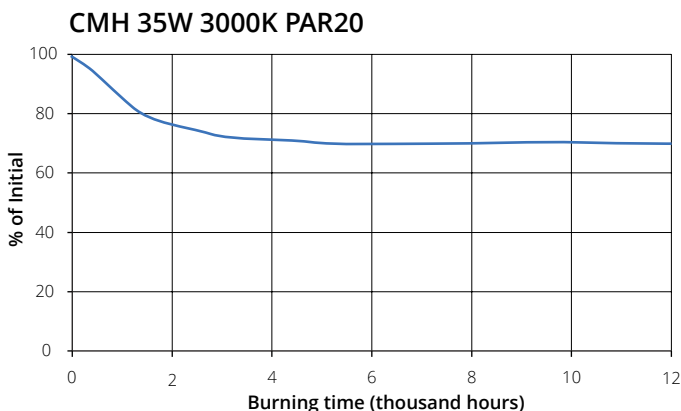

Warm-up characteristics

During the warm-up period immediately after starting, lamp temperature increases rapidly and mercury and the metal halides evaporate within the arc-tube. The lamp current and voltage will stabilise in less than 3 minutes. During this period the light output will increase from zero and the colour will approach the correct visual effect as each metallic element becomes vaporised.

CMH 35W 3000K PAR20

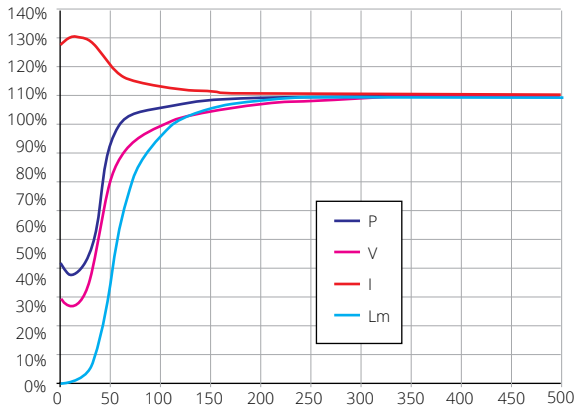

CMH 35W 3000K PAR30

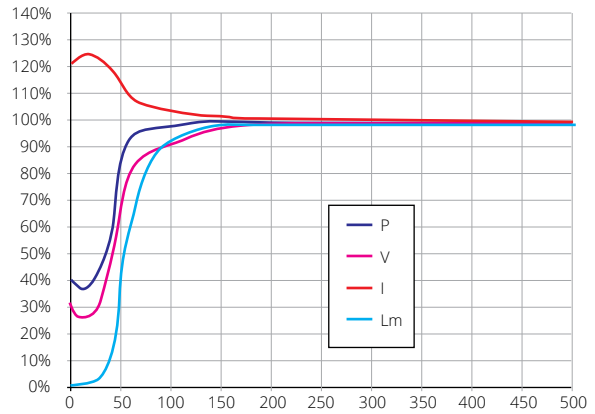

CMH 70W 3000K PAR30

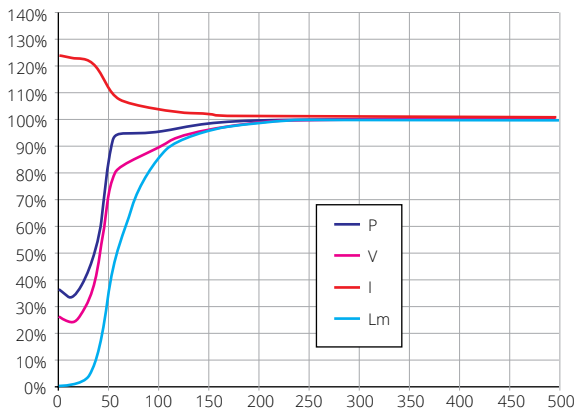

CMH 35W 4200k PAR30

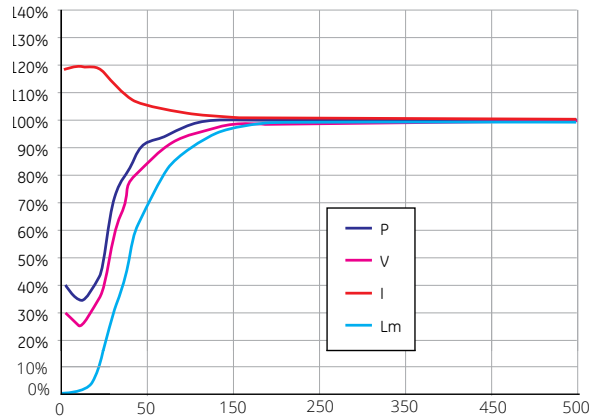

Maximum temperature

The table below shows the maximum temperatures on PAR lamps at different positions. The values are valid for all wattages for both PAR20 and PAR30 lamps.

Location	Maximum temperature
Base	200 °C
Lens seal	160 °C
Bulb	300 °C

Supply voltage sensitivity

The line supply voltage applied to the control gear should be as close to rated nominal as possible. Lamps will start and operate at 10% below rated supply voltage but this should not be considered as a normal operating condition. In order to maximise lamp survival, lumen maintenance and colour uniformity, supply voltage and rated ballast voltage should be within $\pm 3\%$. Supply variations of $\pm 5\%$ are permissible for short periods only. Where supply voltage variation is likely to occur the use of electronic control gear should be considered as this type of equipment is normally designed to function correctly for a voltage range of 220-240V.

Dimming

In certain cases, dimming may be acceptable, subject to further testing. Contact your Tungsham for more information. Large changes in lamp power alter the thermal characteristics of the lamp resulting in lamp colour shift and possible reduction in lamp survival.

Flicker

With conventional ballasts there will be a line frequency (50 Hz) flicker from CMH lamps as with all other discharge lamps. Normally this is not of concern, but, where visual comfort and performance is critical, the use of electronic control gear should be considered. Suitable electronic ballasts for CMH lamps provide square wave operation in the 70-400 Hz range and eliminate perceptible flicker.

End-of-life conditions

The principal end-of-life failure mechanism for CMH lamps is arc tube leakage into the outer jacket. High operating temperature inside the arc tube causes metal halide dose material to gradually corrode through the ceramic arc tube wall, eventually resulting at normal end-of-life in leakage of the filling gas and dose. Arc tube leakage into the outer jacket can be observed by a sudden and significant lumen drop and a perceptible colour change (usually towards green).

The above situation is often accompanied by the so-called rectification phenomena. This occurs where a discharge is established between two mount-frame parts of different material and/or mass, causing asymmetry in the electrical characteristic of the resulting discharge current. Rectification can lead to overheating of the ballast, therefore conventional magnetic ballasts must conform to requirements of the IEC61167 lamp standard by incorporating protection to maintain safety and prevent damage. Lamps designated as CMH70/PAR30 do not require thermally protected ballasts. See Fusing Recommendations.

End-of-life cycling

A condition can exist at end-of-life whereby lamp voltage rises to a value exceeding the voltage supplied by the control gear. In such a case the lamp extinguished and on cooling restarts when the required ignition voltage falls to the actual pulse voltage provided by the ignitor. During subsequent warm-up the lamp voltage will again increase, causing extinction. This condition is known as end-of-life cycling. Normally cycling is an indication that lamp end-of-life has been reached, but it can also occur when lamps are operated above their recommended temperature. Lamp voltage at 100 hours life should not increase by more than 5V when operating in the luminaire, when compared to the same lamp operating in free-air. A good luminaire design will limit lamp voltage rise to 3V.

It is good practice to replace lamps that have reached end-of-life as soon as possible after failure, to minimise electrical and thermal stress on ignitor components. The use of a 'timed' or 'cut-out' ignitor is not a specific requirement for CMH lamps, but is worth considering as a good optional safety feature which also prolongs the life of ignitor internal components, lamp holder contact surfaces, and fixture wiring. The operating period of a timed/cut-out ignitor must be adequate to allow lamps to cool and restart. A period of 10 to 15 minutes continuous or intermittent operation is recommended before the ignitor automatically switches off. Timed/cut-out ignitors, specifically offered for High-Pressure Sodium lamps, where the period of operation is less than 5 minutes, are not suitable for CMH lamps. See Fusing Recommendations.

UV and damage to sensitive materials

The wall of the bulb, which is produced with specially developed 'UV Control' material, absorbs potentially harmful high energy UV radiation emitted by the ceramic arc tube.

The use of UV control material allows the lamp to significantly reduce the risk of discolouration or fading of products. When illuminating light-sensitive materials or at high light levels, additional UV filtration is recommended. Luminaires should not be used if the front glass is broken or missing. Although PET determines limits of human exposure to lamp UV, the risk of fading of merchandise due to UV can be quantified by a Damage Factor and a Risk of Fading. The risk of fading is simply the numerical product of the illuminance, exposure time and damage factor due to the light source.

Finally the selection of luminaire materials should take into consideration the UV emission. Current UV reduction types on the market are optimised for UV safety of human eye and skin exposure. However, luminaire materials may have different wavelength dependent response functions. Designers must take account of emission in each of the UV-A, UV-B and UV-C spectral ranges as well as material temperatures when designing luminaires.

Typical values for UV-A, UV-B and UV-C range radiation can be found in the table below.

Lamp type		35W PAR20	35W PAR30	35W 4K PAR20	70W PAR30	70W 4K PAR30
UV-PET Performance						
UV-C ¹	200-280nm	0.0001	0.0001	0.0000	0.0001	0.0001
UV-B ¹	280-315nm	0.0005	0.0012	0.0014	0.0008	0.0000
UV-A ¹	315-400nm	4.5537	8.8304	9.2583	5.3727	5.1499
UVC/UVB		0.1143	0.0682	0.0000	0.0707	8.2422
UVB/UVA		0.0001	0.0001	0.0002	0.0002	0.0000
E_{eff}^2 mW / (m ² *klx)		0.0004	0.0009	0.0008	0.0005	0.0071
PET (h)±10%		1982	936	1043	1638	2358
Risk Group	IESNA RP-27.3-96	Exempt	Exempt	Exempt	Exempt	Exempt

¹ μW / (cm²) / 500 Lux

² mW / (m²*klx)

Information on luminaire design

Ballasts

CMH lamps operate from the same type of ballast as conventional quartz technology metal halide lamps of the same nominal power. IEC 61167 MH lamp standard and IEC 62035 HID lamp safety standard specify use of ballast thermal protection or equivalent protection device in the circuit, if required by the manufacturer. This safety device will protect the ballast and fixture from overheating damage at lamp end-of-life should rectification occur due to electrode imbalance or arc tube failure. The IEC61167 requirement applies to both ceramic and quartz arc tube metal halide lamps of the UV-A, UV-B, and UV-C spectral ranges as well as material temperatures when designing luminaires. CMH lamps are compatible with a list of approved ballasts; contact your Tungstram for more information.

Stray magnetic field of conventional ballasts

At the design stage for fixtures incorporating the control gear, careful consideration should be given to the physical layout of the lamp and ballast. The relative positions and distance between lamp and ballast can adversely affect lamp performance and drastically reduce lamp survival.

Conventional magnetic ballasts can produce a stray magnetic field and if the lamp is placed within this field, "bowing" of the arc in the discharge tube can occur. Since ceramic is a very rigid material, severe arc bowing can cause high thermal stress leading to cracking or rupture of the arc tube, resulting in failure of the lamp early in life.

Such bowing of the arc can also affect the quartz arc tube in conventional metal halide lamps, but cracking or rupture failure is less likely since quartz softens at the resulting higher wall temperature causing the arc tube to become swollen. Excessive swelling of a quartz arc tube can however also result in cracking or rupture failure.

In fixtures where the ballast is necessarily placed close to the lamp, use of magnetic shielding is essential. Another solution is to use an electronic ballast, which eliminates the need for an ignitor, simplifies wiring, reduces the risk of stray magnetic field, and eliminates light output flicker.

Containment requirement

CMH PAR lamps may be used in open fixtures.

Control gear and accessories

Electronic ballasts

A range of Tungstram electronic ballasts have been introduced to complement the Ceramic Metal Halide lamps. Power controlled electronic ballasts suitable for operation of

Ceramic Metal Halide lamps are available from various gear manufacturers.

Advantages are:

- Good regulation against supply voltage variation
- Improved lamp colour consistency
- Elimination of lamp flicker
- Reduced weight of control gear
- Reduced electrical power losses
- Ballast noise reduced/eliminated
- Single piece compact unit
- Reduced wiring complexity in the luminaire

For selecting proper ballast for CMH lamps please see separate CMH ballasts data sheet.



Superimposed ignitors

In many installations Ceramic Metal Halide lamps are operated from a conventional magnetic ballast in conjunction with a superimposed ignitor. These ignitors generate starting pulses independently from the ballast and should be placed close to the lamp, preferably within the luminaire. Wiring between ignitor and lamp should have a maximum capacitance to earth of 100pF (length equivalent to less than 1 Metre) - contact ignitor manufacturer for details of specific ignitor types. A typical circuit diagram is shown.

Typical superimposed ignitor circuit

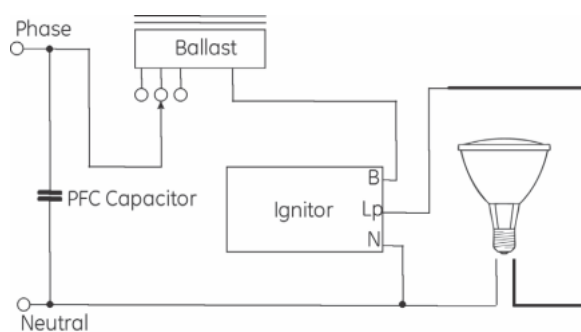

Suitable ignitors

Suitable high-energy (superimposed) ignitors are listed below recommended by gear manufacturers. Check with your supplier for their current range of ignitors. Lamp re-starting under warm lamp conditions can take up to 15 minutes. Suitable ignitors with a warm restart of less than 15 minutes include the following, however the list may not be fully inclusive.

Maker	Products		
APF	SP23		
BAG Turgi	NI 150 SE-CM	NI 400 LE 4K	NI 400 LE 4K-TM20
ERC	ASP 1.8	ASP 1.8 T22	ASP 3.0
Helvar	L-150	LSI-150T20	
Optima	ZG 4.5 D		
Parmar	PAE400255		
Philips	SU20S	SU20T20S	
Thorn	G53459	G53455	
Tridonic	ZRM 1.8-ES/B	ZRM 2.5-ES/D	ZRM 4.5-ES/B
Vossloh-Schwabe	Z 250	Z 250 K D20	

Impulser ignitors

Impulser type ignitors use the ballast winding as a pulse transformer and can only be used with a matched ballast. Always check with the ballast and ignitor supplier that components are compatible. Longer cable lengths between ballast & ignitor and the lamp are possible due to the lower pulse frequency generated, giving greater flexibility for remote control gear applications. Ignitor pulse characteristics at the lamp must however comply with specified minimum values for CMH lamps under all conditions.

Typical impulser ignitor circuit

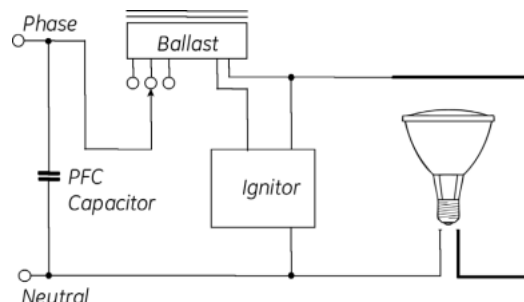

Other ignitor related considerations

Timed or cut-out ignitors

The use of a 'timed' or 'cut-out' ignitor is not a specific requirement for CMH lamps but it is a good optional safety feature worth considering to protect the ignitor from overheating and to prolong its life. If used, the timed period must be adequate to allow lamps to cool and restart as described in the previous section. A period of 10-15 minutes continuous or intermittent operation is recommended before the ignitor automatically switches off. Timed ignitors specifically offered for High-Pressure Sodium lamps where the period of operation is only about 5 minutes are not suitable for CMH lamps. Instant hot re-strike is only possible using a suitable very high voltage ignitor and double-ended lamp. Tungsham Lighting should be consulted when considering use of an instant hot re-striking system.

Hot re-strike

All ratings re-strike within 15 minutes following a short interruption in the supply. Hot re-strike may be achieved using a suitable ignitor. Actual re-strike time is determined by the ignitor type, pulse voltage and cooling rate of the lamp.

Warm re-starting

Because of the ceramic materials and the vacuum jacket ConstantColor CMH™ lamps loose their heat slowly. It is possible with low energy (impulser) ignitors to reach the required breakdown voltage, but not sustain a thermionic discharge. Under these conditions the lamp can remain warm and be prevented from cooling to a temperature at which the arc can be re-established. To avoid this, turn off the power supply for approximately fifteen minutes or change to a suitable ignitor from the list given in the superimposed ignitor section.

Fusing recommendations

For a very short period immediately after switch-on, all discharge lamps can act as a partial rectifier and the ballast may allow higher than the normal current to flow. In order to prevent nuisance fuse failure the fuse ratings must take account of this.

Number of Lamps	1	2	3	4	5	6
35W Fuse Rating (A)	4	4	4	4	4	6
70W Fuse Rating (A)	4	4	4	6	10	10

See relevant information on national installation requirements for High Intensity Discharge lighting circuits. Single fusing is recommended which gives added protection for the end-of-life condition when partial rectification can also occur.

HBC or MCB (type 3 or 4) fuse ratings for single and multiple lamp installations

Safety warnings

The use of these products requires awareness of the following safety issues:

Warning:

- Risk of electric shock - isolate from power before changing lamp.
- Strong magnetic fields may impair lamp performance.
- Do not use where directly exposed to water or outdoors without an enclosed fixture.
- Keep combustible materials away from lamp.
- A damaged lamp emits UV radiation which may cause eye/skin injury.
- Unexpected lamp rupture may cause injury, fire, or property damage.
- Use only properly rated ballast and supply voltage.
- Do not use beyond rated life

Caution:

- Risk of burn when handling hot lamp.
- Allow lamp to cool before handling.
- Do not turn on lamp until fully installed.
- Lamp may shatter and cause injury if broken.
- Do not use lamp if outer glass is scratched or broken.
- Arc tube fill gas contain Kr-85.
- Dispose of lamps in accord with local regulations.

Always follow the supplied lamp operation and handling instructions.