

Ceramic Metal Halide Lamp

MR16

Reflector 20W and 35W



DATA SHEET

Product information

CMH lamps combine HPS technology (providing stability, efficiency & uniformity) and Metal Halide Technology (providing bright white quality light) to produce highly efficient light sources with good colour rendering and consistent colour performance through life. This is achieved by using the ceramic arc tube material from the Lucalox lamp, which minimises the chemical changes inside the lamp through life.

Tungshram has now miniaturized this technology resulting in the CMH Precise MR16, highly efficient 20 & 35 Watt lamps with the light quality and colour stability associated with Ceramic Metal Halide, in a size comparable to tungsten halogen reflector lamps, thus offering new energy saving options to the lighting designer and end user.

Features

- Consistent colour over life
- Excellent colour uniformity lamp to lamp
- Bright light – in a very compact size
- Excellent colour rendition
- High reliability due to 3 part ceramic design
- Up to 56 beam Lumens per Watt (LPW) efficacy
- Long Life
- UV control
- 35W available in two colour temperatures
- Robust GX10 base

Application areas



Office



Retail



Hospitality



Commercial areas / city beautification / architectural

Specification summary

Watts	Operating Position	Length [mm]	Order Code	Cap / Base	Colour	CBCP [cd]	Rated Average Life [Hr]	Pack Qty	Product Code
20	U	54.5	CMH20/MR16/UVC/U/830/GX10/SP TU	GX10	830	9000	12000	12	93102192
20	U	54.5	CMH20/MR16/UVC/U/830/GX10/FL TU	GX10	830	2900	12000	12	93102193
20	U	54.5	CMH20/MR16/UVC/U/830/GX10/WFL TU	GX10	830	1500	12000	12	93102196
35	U	54.5	CMH35/MR16/UVC/U/930/GX10/SP TU	GX10	930	16000	10000	12	93102224
35	U	54.5	CMH35/MR16/UVC/U/930/GX10/FL TU	GX10	930	5500	10000	12	93102225
35	U	54.5	CMH35/MR16/UVC/U/930/GX10/WFL TU	GX10	930	3000	10000	12	93102226
35	U	54.5	CMH35/MR16/UVC/U/942/GX10/SP TU	GX10	942	16000	12000	12	93102227
35	U	54.5	CMH35/MR16/UVC/U/942/GX10/FL TU	GX10	942	5500	12000	12	93102228
35	U	54.5	CMH35/MR16/UVC/U/942/GX10/WFL TU	GX10	942	3000	12000	12	93102229

General

Product Code	93102192	93102193	93102196	93102224	93102225	93102226	93102227	93102228	93102229
Nominal Wattage [W]	20	20	20	35	35	35	35	35	35
Format	MR16	MR16	MR16	MR16	MR16	MR16	MR16	MR16	MR16
Bulb Type	MR16	MR16	MR16	MR16	MR16	MR16	MR16	MR16	MR16
Bulb Diameter [mm]	51	51	51	51	51	51	51	51	51
Bulb Material	Borosilicate glass	Borosilicate glass	Borosilicate glass	Borosilicate glass	Borosilicate glass	Borosilicate glass	Borosilicate glass	Borosilicate glass	Borosilicate glass
Bulb Finish	Aluminized	Aluminized	Aluminized	Aluminized	Aluminized	Aluminized	Aluminized	Aluminized	Aluminized
Mercury Content [mg]	2.3	2.3	2.3	4.5	4.5	4.5	3.8	3.8	3.8

Operating Conditions

Burning Position	Universal	Universal	Universal	Universal	Universal	Universal	Universal	Universal	Universal
Luminaire	Open	Open	Open	Open	Open	Open	Open	Open	Open

Electrical Characteristics

Rated power [W]	19.8	19.7	19.8	38.4	38.3	38.4	38.4	38.4	38.4
Weighted Energy Consumption [kWh/1000 hrs]	21.73	21.7	21.76	42.21	42.17	42.21	42.26	42.24	42.2
Voltage [V]	95	95	95	90	90	90	90	90	90
Current [A]	0.21	0.21	0.21	0.42	0.42	0.42	0.42	0.42	0.42
Max Ignition Voltage [kV]	4	4	4	5	5	5	5	5	5
Min Ignition Voltage [kV]	3	3	3	3	3	3	3	3	3
Extinction Voltage [%]	80	80	80	90	90	90	90	90	90

Photometric characteristics

	12° Spot	25° Flood	40° Wide Flood	12° Spot	25° Flood	40° Wide Flood	12° Spot	25° Flood	40° Wide Flood
Nominal Beam Angle	12° Spot	25° Flood	40° Wide Flood	12° Spot	25° Flood	40° Wide Flood	12° Spot	25° Flood	40° Wide Flood
Rated Beam Angle	11	27	38	13	30	38	13	29	41
CBCP	9000	2900	1500	16000	5500	3000	16000	5500	3000
Rated Peak Intensity	9289	2915	1847	16826	5339	3895	17378	5943	3413
Nominal Luminous Flux [L]	1000	1000	1000	2200	2200	2200	2200	2200	2200
Nominal Useful Lumens (90° Cone) [L]	882	849	857	2066	2006	1987	1997	1943	1866
Rated Useful Lumens (90° Cone) [L]	882	849	857	2066	2006	1987	1997	1943	1866
CCT [K]	3000	3000	3000	3000	3000	3000	4000	4000	4000
CCx	0.431	0.431	0.431	0.444	0.444	0.444	0.377	0.377	0.377
CCy	0.403	0.403	0.403	0.401	0.401	0.401	0.365	0.365	0.365
CRI [Ra]	81	81	81	90	90	90	92	92	92
Nominal Luminous Efficacy [lm/W]	50	50	50	56	56	56	56	56	56
Energy Efficiency Class (EEC)	A	A	A	A	A	A	A	A	A

Starting and Warm-up Characteristics

Time to Start @ 10C [Sec]	<5	<5	<5	<5	<5	<5	<5	<5	<5
Time to Start @ -15C [Sec]	<15	<15	<15	<15	<15	<15	<15	<15	<15
Switching cycles	1091	1091	1091	909	909	909	1091	1091	1091
Hot Restart Time [Min]	<4	<4	<4	<10	<10	<10	<10	<10	<10
Warm-up to Time to 90% Lumen Output [Min]	<1.5	<1.5	<1.5	<1.5	<1.5	<1.5	<1.5	<1.5	<1.5
Warm-up to Time to 60% Lumen Output [Sec]	90	90	90	60	60	60	60	60	60

Maximum Operating Conditions

Max Bulb Temperature ¹ [°C]	200	200	200	300	300	300	300	300	300
Max Base Temperature ² [°C]	200	200	200	300	300	300	300	300	300

¹ Measured at centre of MR16 lens, in vertical base-up position

² Measured on 25mm GX10 ceramic cap rim, at transition to 23mm diameter

Dimensions

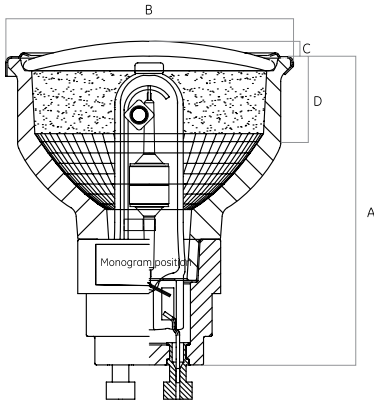

A Length (max) [mm]	54.5
B Diameter (max) [mm]	51
C (max) [mm]	3.5
D (max) [mm]	14

Spectral power distribution

Spectral power distribution curves are given in the following diagrams.

Spectral power distribution CMH MR16 20W 830

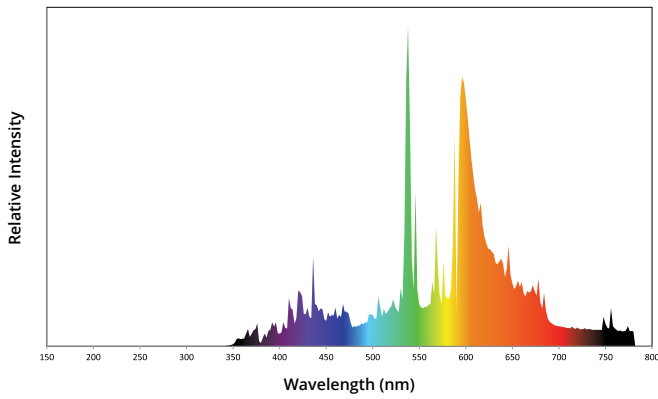

Spectral power distribution CMH MR16 35W 930

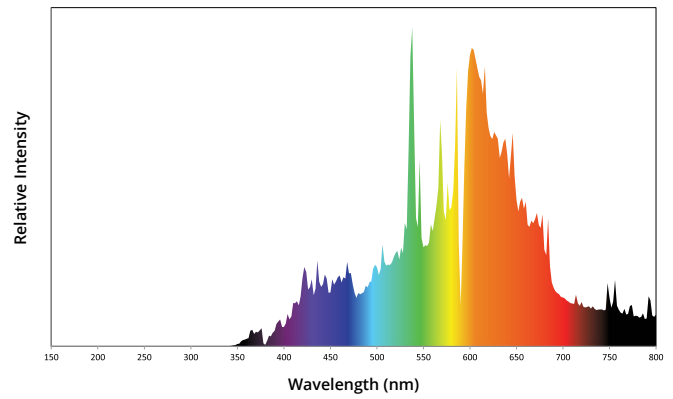

Spectral power distribution CMH MR16 35W 942

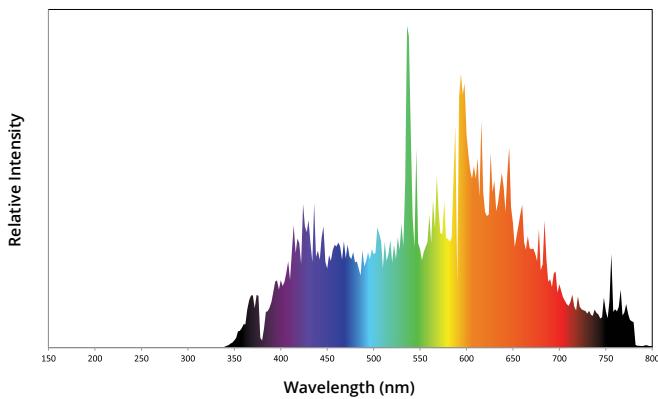

Distribution of luminous intensity

The following diagrams show polar light intensity curves and beam diagrams for vertical base-up orientation

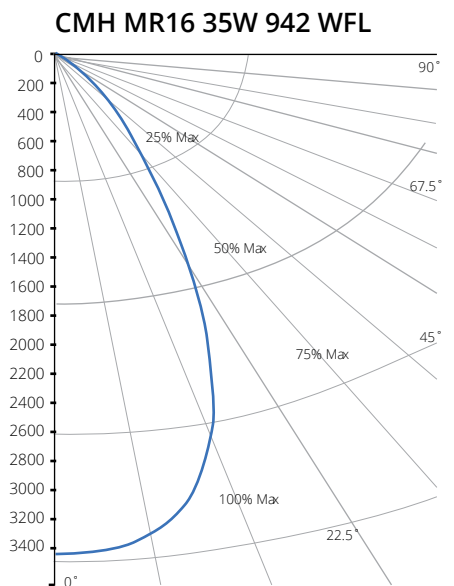
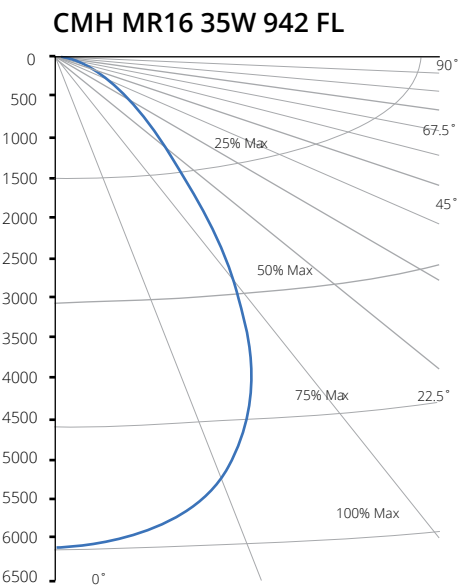
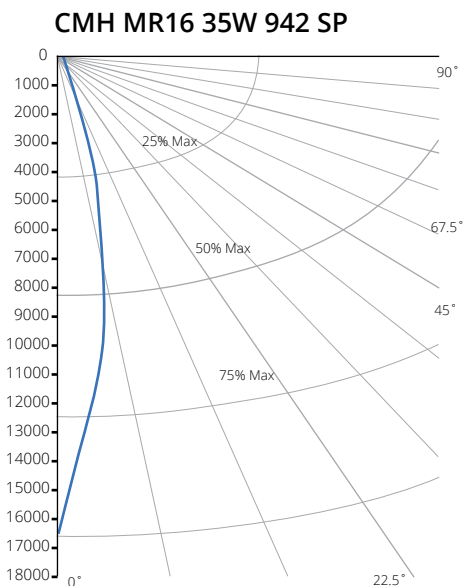
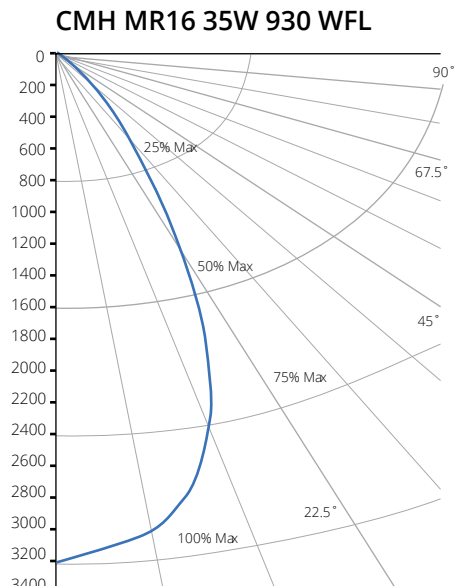
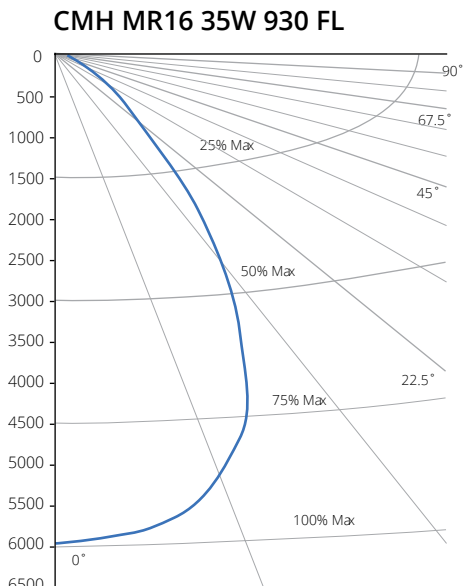
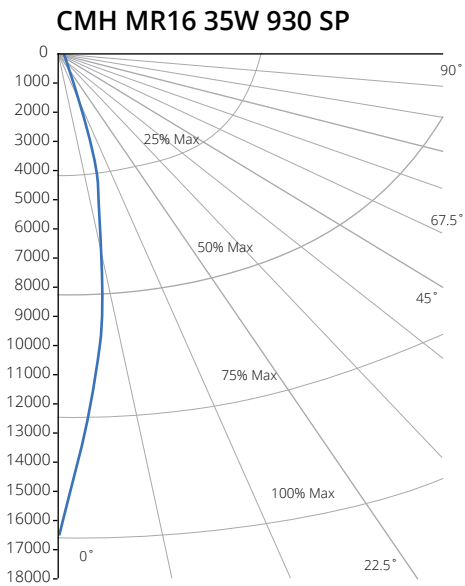
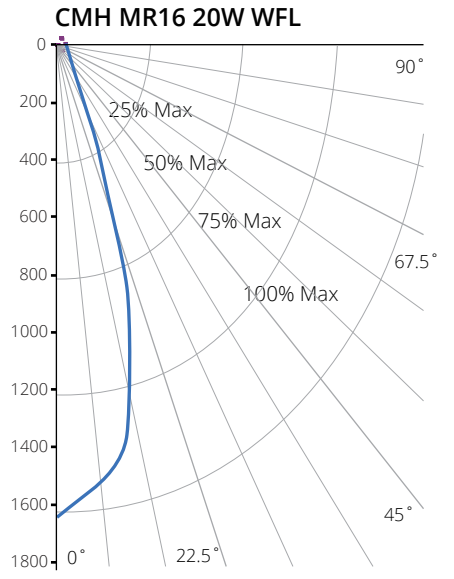
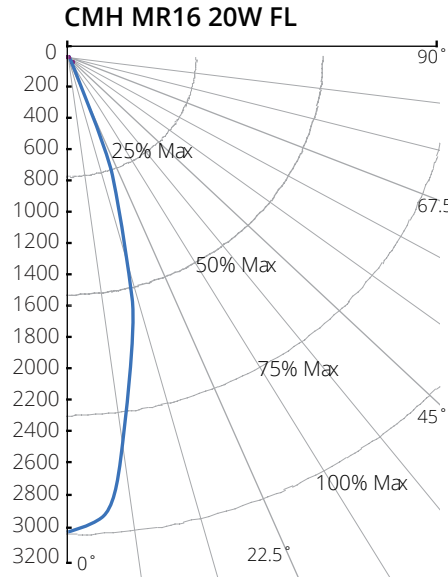
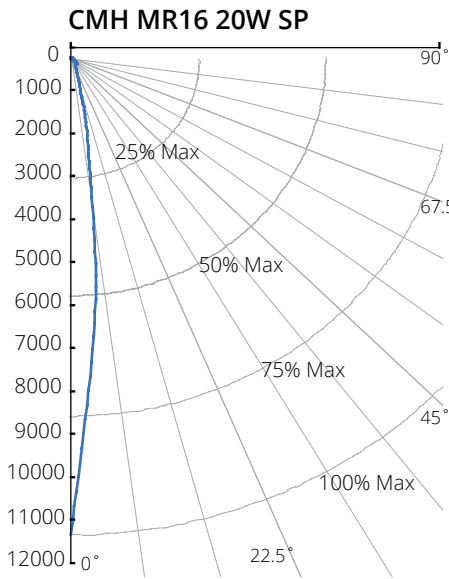

Beam diagrams

CMH20/MR16/UVC/830/GX10/SP

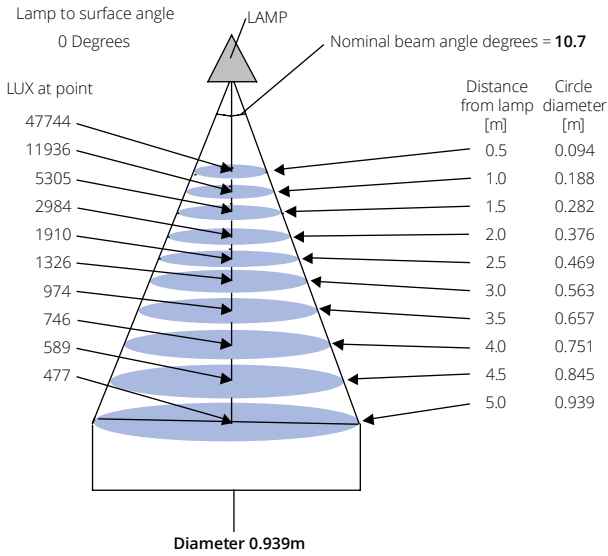

CMH20/MR16/UVC/830/GX10/FL

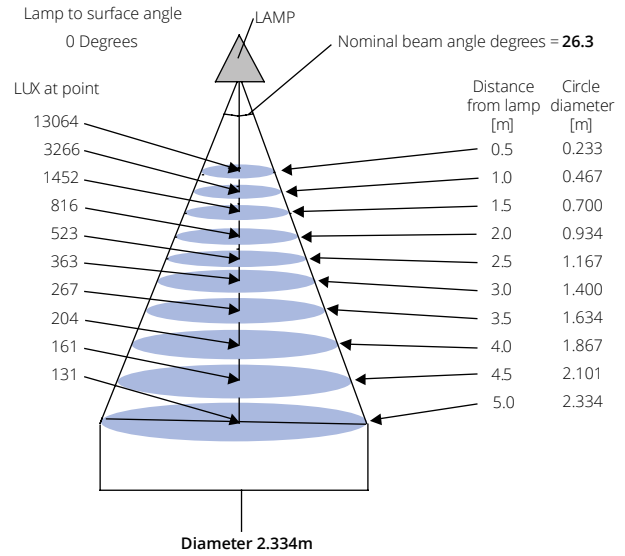

CMH20/MR16/UVC/830/GX10/WFL

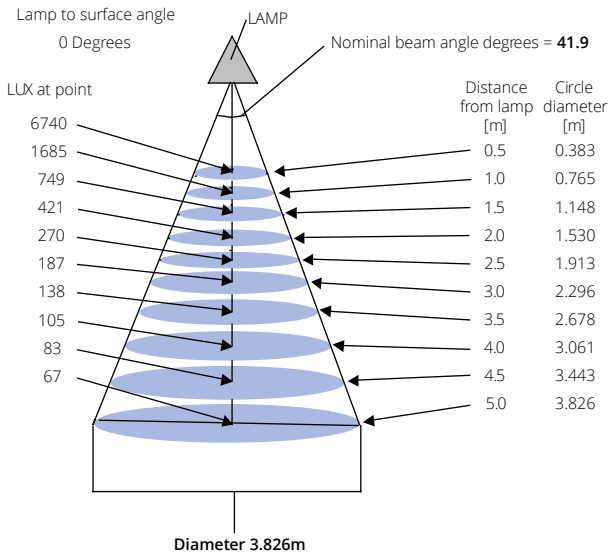

CMH35/MR16/UVC/930/GX10/SP

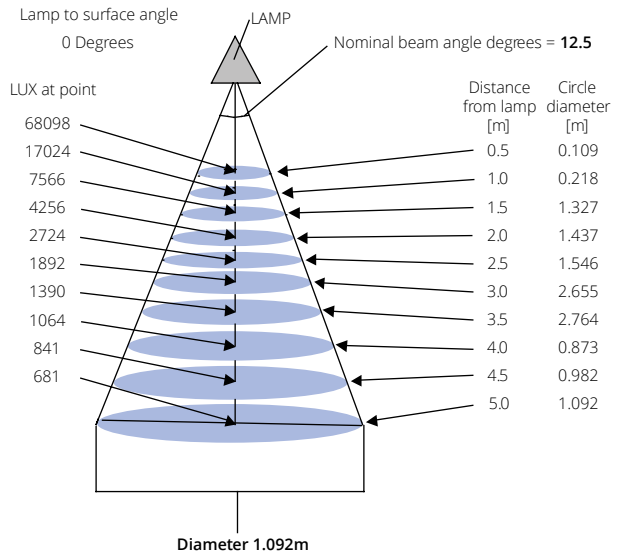

CMH35/MR16/UVC/930/GX10/FL

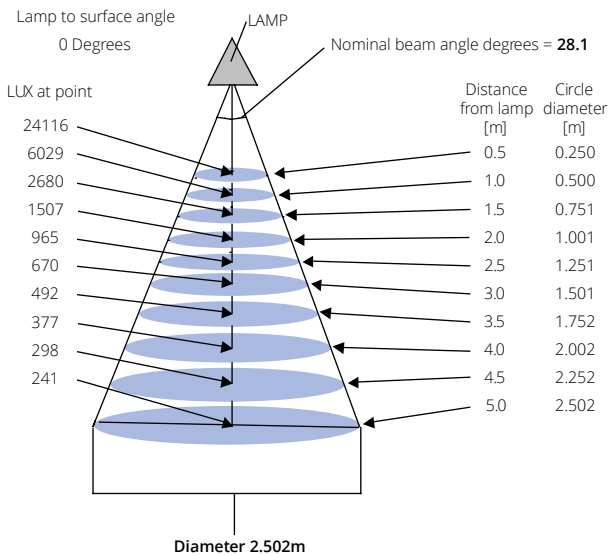

CMH35/MR16/UVC/930/GX10/WFL

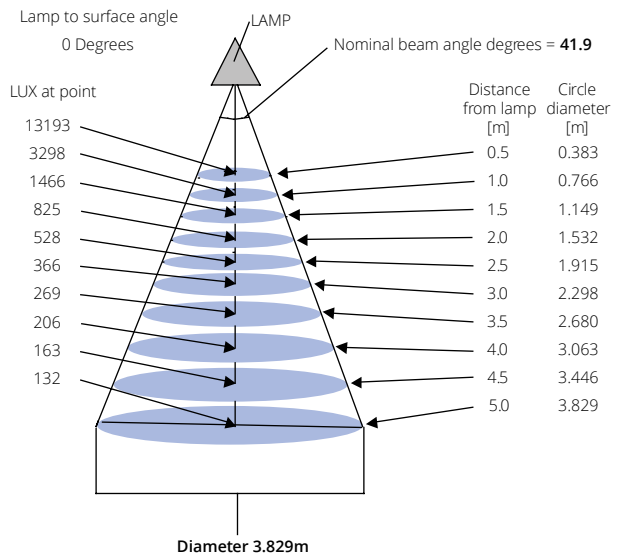

CMH35/MR16/UVC/942/GX10/SP

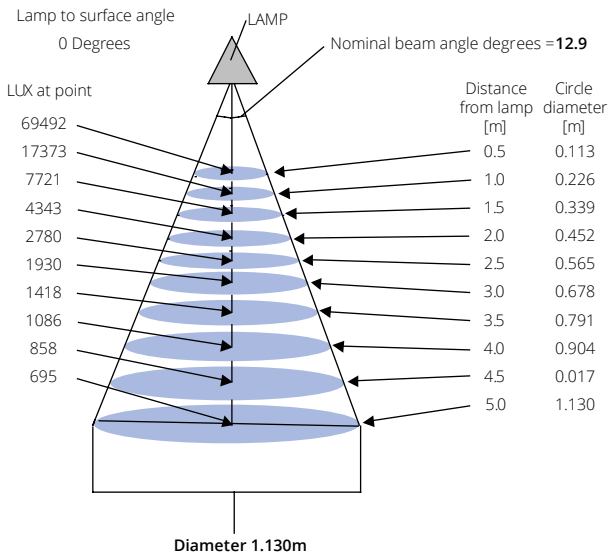

CMH35/MR16/UVC/942/GX10/FL

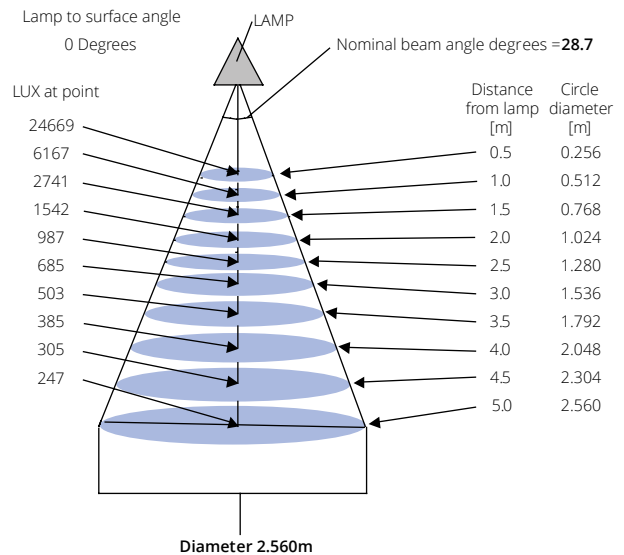

CMH35/MR16/UVC/942/GX10/WFL

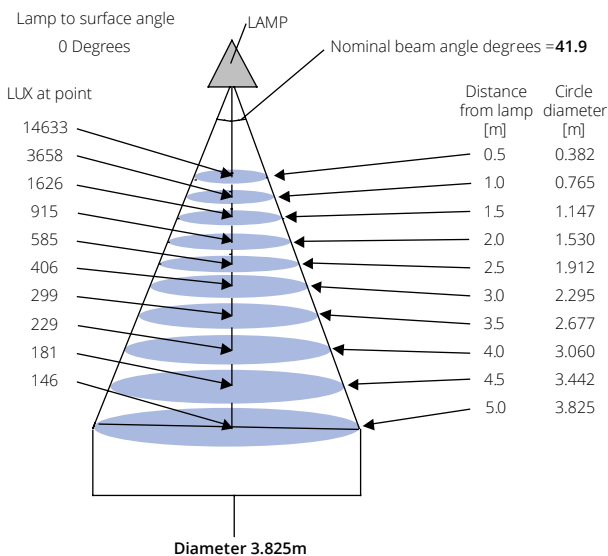

Lamp life

Life survival graphs are shown for statistically representative batches of lamps operated under controlled nominal conditions with a 11 hours per start switching cycle. Declared lamp life is the median value, i.e. when 50% of lamps from a large sample batch would have failed. Lamp life in service is affected by a number of parameters, including supply voltage variation, switching cycle, operating position, mechanical vibration, luminaire design and control gear.

The information provided is intended to be a practical guide for comparison with other lamp types. Determination of lamp replacement schedules will depend upon relative costs of spot or group replacement and acceptable reduction in lighting levels.

Note: Representative curves are shown for Vertical Base-Up lamp orientation unless otherwise specified. Life performance increases in the Horizontal burning position.

CMH20MR16/830

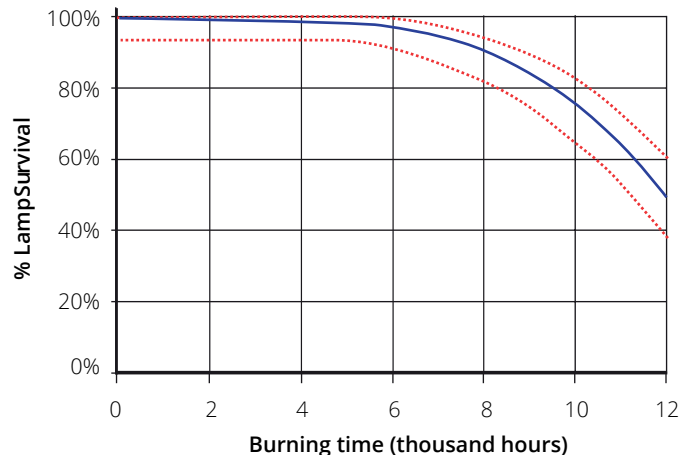

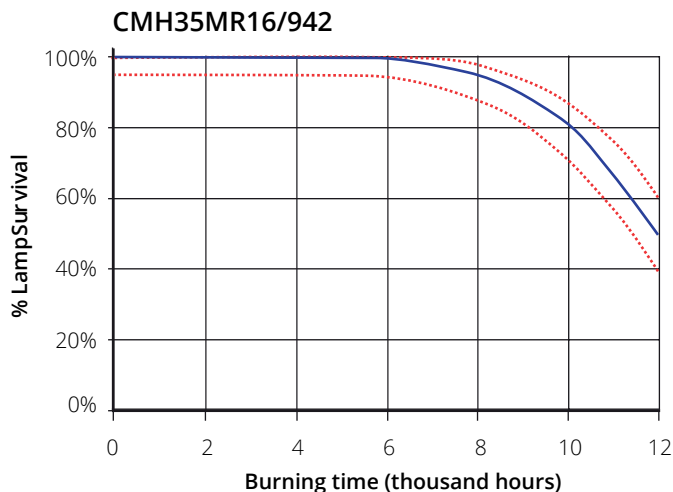
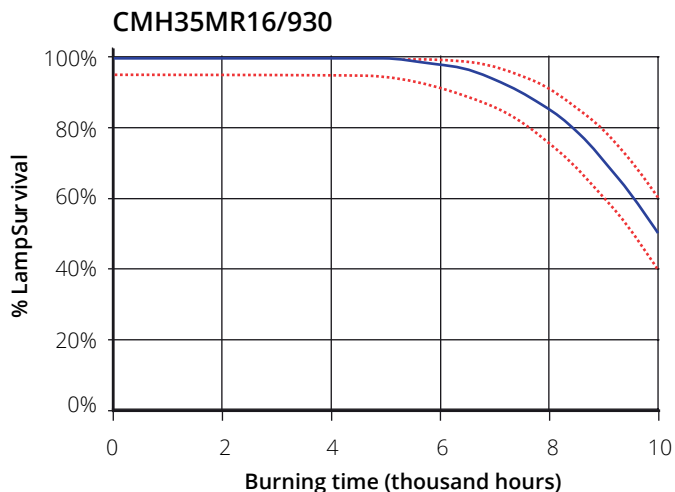

Lumen maintenance

Lumen maintenance graphs show light output performance through life for statistically representative batches of lamps operated under controlled nominal conditions with a 11 hours per start switching cycle.

A common characteristic for all metal halide lamps is a reduction in light output and a slight increase in power consumption through life. Consequently there is an economic life at which lamp efficacy falls to a level when lamps should be replaced to restore design illumination levels. Where multiple lamps are installed within an area, consideration should be given to a group lamp replacement programme to maintain uniform illumination levels.

Curves represent operating conditions for a 11 hours per start switching cycle, but less frequent switching will improve lumen maintenance.

Note: The representative curves are shown for Vertical Base-Up lamp orientation unless otherwise specified. Lumen maintenance performance improves when operated in the Horizontal burning position.

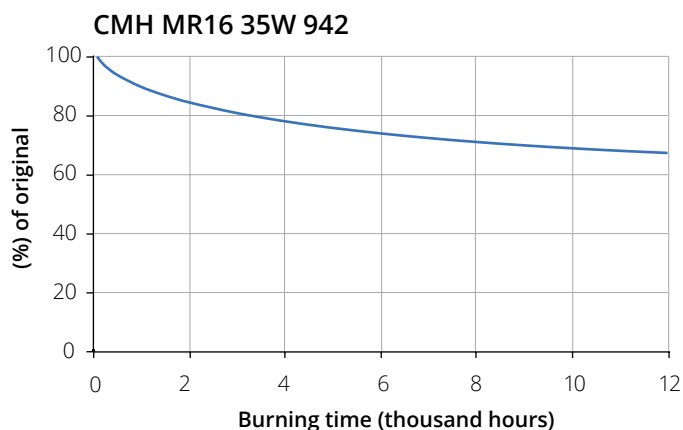
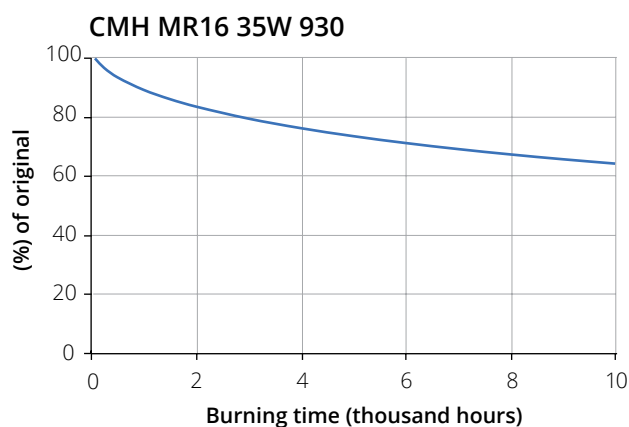
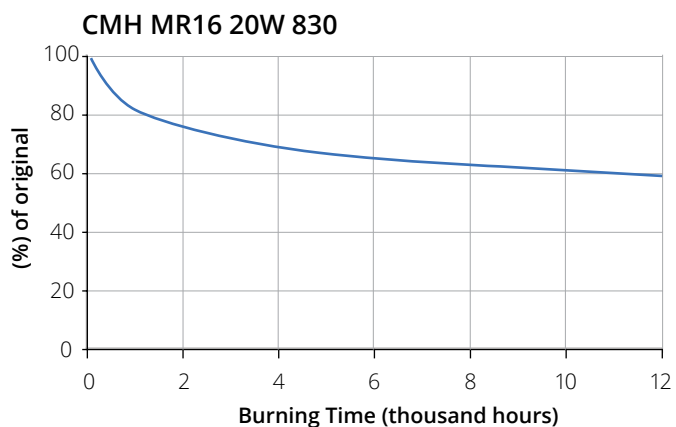

Warm-up characteristics

During the warm-up period immediately after starting, lamp temperature increases rapidly evaporating mercury and metal halide dose in the arc-tube. Lamp electrical characteristics and light output stabilise in less than 4 minutes. During this period light output increases from zero to full output and colour approaches the final visual effect as each metallic element becomes vaporised.

CMH MR16 20W typical warm-up characteristics

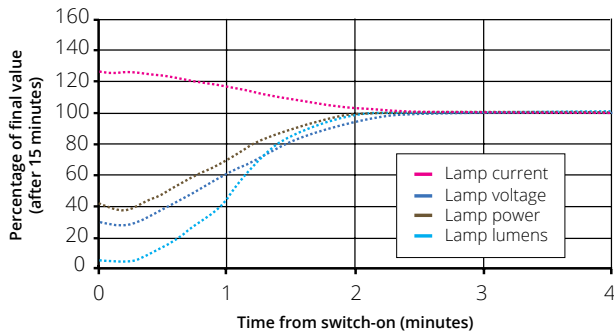

CMH MR16 35W typical warm-up characteristics

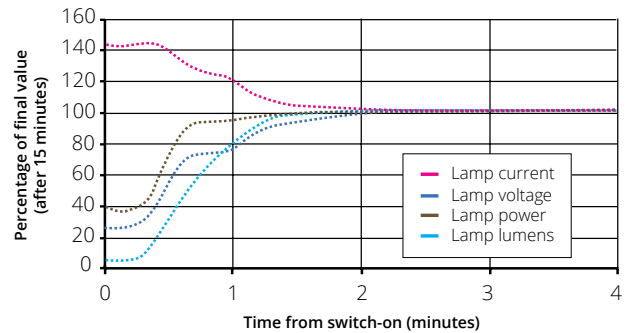

Dimming

In certain cases, dimming may be acceptable, subject to further testing. Contact your Tungsram for more information. Large changes in lamp power alter the thermal characteristics of the lamp resulting in lamp colour shift and possible reduction in lamp survival.

Flicker

Suitable electronic ballasts for CMH lamps provide square wave operation in the 70-400 Hz range and eliminate perceptible flicker.

Lamp end-of-life conditions

The principal end-of-life failure mechanism for CMH lamps is arc tube leakage into the outer jacket. High operating temperature inside the arc tube causes metal halide dose material to gradually corrode through the ceramic arc tube wall, eventually resulting at normal end-of-life in leakage of the filling gas and dose. Arc tube leakage into the outer jacket can be observed by a sudden and significant lumen drop and a perceptible colour change (usually towards green).

The above situation can be accompanied by the so-called rectification phenomena. This occurs where a discharge is established between two mount-frame parts of different material and/or mass, causing asymmetry in the electrical characteristic of the resulting discharge current. Rectification can lead to overheating of the ballast, therefore to maintain safety use electronic ballast or system which can shut itself off if ballast overheating occurs.

End of life cycling

A possible condition can exist at end-of-life whereby lamp voltage rises to a value exceeding the voltage supplied by the control gear. In such a case the lamp extinguishes and on cooling restarts when the required ignition voltage falls to the actual pulse voltage provided by the gear. During subsequent warm-up the lamp voltage will again increase, causing extinction. This condition is known as end-of-life cycling. With electronic ballasts, cycling is unlikely.

Normally cycling is an indication that lamp end-of-life has been reached, but it can also occur when lamps are operated above their recommended temperature. Lamp voltage at 100 hours life should not increase by more than 5V when operating in the luminaire, when compared to the same lamp operating in free-air. A good luminaire design will limit lamp voltage rise to 3V.

It is good practice to replace lamps that have reached end-of-life as soon as possible after failure, to minimise electrical and thermal stress on control gear components.

UV and damage to sensitive materials

The wall of the bulb, which is produced with specially developed 'UV Control' material, absorbs potentially harmful high energy UV radiation emitted by the ceramic arc tube.

The use of UV control material allows the lamp to significantly reduce the risk of discolouration or fading of products. When illuminating light-sensitive materials or at high light levels, additional UV filtration is recommended. Luminaires should not be used if the front glass is broken or missing.

Although PET determines limits of human exposure to lamp UV, the risk of fading of merchandise due to UV can be quantified by a Damage Factor and a Risk of Fading. The risk of fading is simply the numerical product of the illuminance, exposure time and damage factor due to the light source.

Finally the selection of luminaire materials should take into consideration the UV emission. Current UV reduction types on the market are optimised for UV safety of human eye and skin exposure. However, luminaire materials may have different wavelength dependent response functions. Designers must take account of emission in each of the UV-A, UV-B and UV-C spectral ranges as well as material temperatures when designing luminaires.

Typical values for UV-A, UV-B and UV-C range radiation can be found in the table next page.

UV PET performance – data from bare lamp

Product name	UV-C ¹	UV-B ¹	UV-A ¹	UVC/UVA	UVB/UVA	E _{eff} ²	PET (h)	Risk Group
	200-280 nm	280-315 nm	315-400 nm					
CMH20MR16/830	0,0014	0,0006	6,650	0,0002	0,0001	0,018	939	Exempt
CMH35MR16/930	0,0003	0,0002	4,344	0,0001	0,0000	0,010	1765	Exempt
CMH35MR16/942	0.0003	0,0005	9.428	0,0000	0,0000	0.014	1184	Exempt

¹ $\mu\text{W} / (\text{cm}^2) / 500 \text{ Lux}$

² $\text{mW} / (\text{m}^2 * \text{klx})$

Information for luminaire design

Electronic ballast operation

CMH 20W and CMH 35W have optimum performance on electronic gear.* This provides many advantages:

- Flicker free light output
- Well controlled electronic ignition process
- Simple wiring for fixtures due to elimination of ignitor and PFC capacitor
- Reduces fixture weight
- Automatic sensing of failed lamps and shutdown
- Lower overall system power consumption

*For details of approved electronic ballasts for CMH lamps please consult your Tungfram.

CMH 20W is designed only for operation on electronic gear

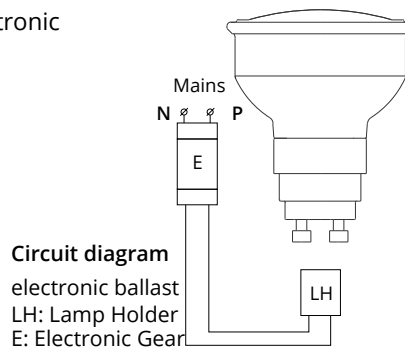

Containment Requirement

CMH Precise MR16 lamps may be used in open fixtures.

Control gear and accessories

Electronic ballasts

Electronic HID ballasts are designed to allow optimal performance of our range of CMH lamps, offering reduced power consumption, regulated power through life, simplified circuitry and more stable lamp operation compared to electromagnetic systems.

Please consult Tungstram for up to date details on approved ballasts.

Advantages:

- Good regulation against supply voltage variation
- Improved lamp colour consistency
- Elimination of lamp flicker
- Reduced weight of control gear
- Reduced electrical power losses
- Ballast noise reduced/eliminated
- Single piece compact unit
- Reduced wiring complexity in the luminaire



Safety warnings

The use of these products requires awareness of the following safety issues:

Warning

- Risk of electric shock - isolate from power supply before changing lamp
- Strong magnetic fields may impair lamp performance and worst case can lead to lamps shattering
- Risk of fire
- A damaged lamp emits UV radiation which may cause eye/skin injury, remove and dispose of broken lamp
- Unexpected lamp shattering may cause injury, fire or property damage

Caution

- Risk of burn, allow lamp to cool before handling
- Lamp may shatter and cause injury if broken
- Arc tube fill gas contains Kr-85

Always follow the supplied lamp operation and handling instructions.